

TRESTON

DEDICATED TO HUMAN WORKSPACE



DISTINCTIVE WORKSHOPS

3D ONLINE CONFIGURATOR

CLICK • DESIGN • QUOTE



<https://3d.treston.com/>



About us

Dedicated to human workspace	5
Workstation ergonomics	8
Decorating with colour	10



Workbenches and accessories

Workshop	14
TP and TPH	18
Accessories for Workshop and TP	24
Accessories for TPH	30



Lighting

33



Chairs

38

Chairs and accessories	41
------------------------	----

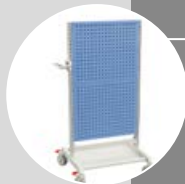

Trolleys

47

Heavy-duty trolley	50	Basic trolley	54
Fitter's trolley	51	Storage trolley	55
Service trolley	52		



Drawer units

57

Drawer unit 45	59
Drawer unit 55	60
Drawer unit 71	63
Drawer units 70, 90 and 130	64



Shelves and cabinets

75

Storage system	78
Heavy storage system	81
Industrial cabinets	84

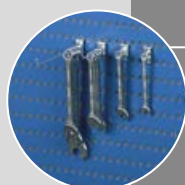

Perforated panels and tool storage systems

91

Perforated back and wall panels	94
Industrial screens	95
Tool storage system	96
Treston Tower storage and workstation unit	97
Panel hooks	98





For a Better Work Environment

DEDICATED TO HUMAN WORKSPACE

Treston is among the world's leading suppliers of industrial furniture and workstations.

Our workstation design and implementation process always begins with the person performing the work. In this way, we pay close attention to ergonomics, functionality and efficiency.

The four cornerstones of our operations are customer focus, reliability, high quality and continuity. We listen to your needs and reliably deliver high quality and durable solutions, which last from one generation to the next, thanks to our optimal design.

Our own sales network and retailers dedicated to our products provide worldwide assistance and service in support of Treston products.



Industrial furniture and workstations for different working environments

Treston's product range is divided into three categories, a separate catalogue is available for each category. Please contact our agents or email us at: sales@treston.com to get your own copy.

Distinctive workshops

Our workshop drawer cabinets, tool panels and workbenches are designed to withstand heavy loads and strenuous use in workshops, repair shops and industrial environments.

The long lifetime of our furniture guarantees productivity and a satisfied user. Our workshop furniture is also well known in teaching environments.

Ergonomic workstations

The seamless efficiency of material flow is emphasised in assembly workstations.

Process changes in production or operations require reconfigurable workstations that take account of individual ergonomic requirements. Our modular product solutions allow you to react to new situations and the resulting needs in an agile manner, enabling smooth, continuous operations. Thanks to our extensive selection of accessories, we are able to satisfy even the most challenging requirements.

Treston design and years of experience enable us to customise each solution to best suit its purpose. For the needs of the electronics industry, we make ESD-protected workstations, suitable for furnishing EPAs. These workstations are also highly suitable for precision mechanics and mechanical engineering.

Swift in-house logistics

Treston storage furniture encompasses both ease of use and design. Our selection provides solutions to a surprisingly broad range of storage challenges, regardless of the users and sector.

Our plastic storage drawers are durable and easy to clean, and can be customised into a complete storage system if necessary. Our product range also includes various stand and trolley solutions, for the more efficient use of storage space and easier movement of stored goods.

We also have storage furniture for environments that require ESD protection. In addition, some of our storage solutions are moulded from recycled plastic.

Packaging and shipping departments are often found at the end of production processes. Their logistic efficiency can be easily improved through sensible workstation design.

A great deal of manual labour and quality assurance are typical of the packaging stage, in both individual stations and line solutions. Our solution for the needs of these segments often builds on the idea of "more for less".

When accessories are located and positioned according to LEAN principles, you can significantly speed up throughput and reduce work strain. Cutters, pens, knives, rubbish bins and displays can be positioned in a way that provides the user with the best possible ergonomics, while also ensuring a free and uncluttered workspace.

Workstations for every need

Optimising workstation functionality may prove difficult without well chosen accessories that increase usability. When a workstation is well planned and well equipped, workflow becomes easier and more efficient, improving ergonomics and making it easier to keep tools in place.

Modular means adaptable

Our world keeps changing at an ever-increasing pace. Until recently, products could be manufactured the same way for decades, but now we must be prepared to make changes to our work practices at a much faster rate. In order to revise the production process to meet new requirements, an extremely flexible and adaptable workstation system is essential. Our system is designed particularly with this in mind. The same basic units, equipped with accessories that meet your needs, offer a wide range of applications.

Customised for your application and your operator

The purpose of a workstation determines its basic requirements and accessories. The needs and requirements may change considerably from one employee to another, but we understand that no two people are alike. When a workstation is equipped for and adjusted to an individual's needs, each phase of the production process can be completed without delay, with accuracy and with maximum comfort.

Treston offers a wide range of ergonomic workstations to choose from, from those that can be delivered quickly to those that provide versatile options to meet any need.





Workstation ergonomics

Costs associated with health and safety problems are an ever increasing concern to all industries. This concern drives industries to seek solutions to provide a healthy, safe and productive working environment. **Designing a workplace with ergonomics in mind improves the employees' wellbeing which in turn improves productivity.**

The modular design of Treston workstations enables proper ergonomics. With a wide range of accessories and adjustments we can provide customers with a customised solution using standard components. **Modular accessories can be individually adjusted according to the task and operator requirements.** The aim is to create an uncluttered workstation and utilise the available workspace as efficiently as possible.

Treston's workstations and accessories can be adjusted for operators of different heights and be left or right handed. Correctly adjusted workstations decrease stress in the muscles and enable productive work throughout the shift.

Please do remember that ergonomics is not only adjusting your chair. Real ergonomics has to do with proper lighting, noise absorption, body movements and air quality. More information about lighting ergonomics on page 34.

Seated or standing work?

The choice of a seated or standing working position is dependent upon the task to be executed. The height of the work surface is determined by such factors as size and weight of the part, precision requirement, assembly process, repetitiveness etc.

Height adjustability is especially useful when the size of the products being handled varies or when several people use the same workstation.

When designing the work space for a seated operation leg space requirements must be considered. The recommended space should be at least 80 cm wide and 90 cm deep at floor level. For standing work, the required space is much smaller.

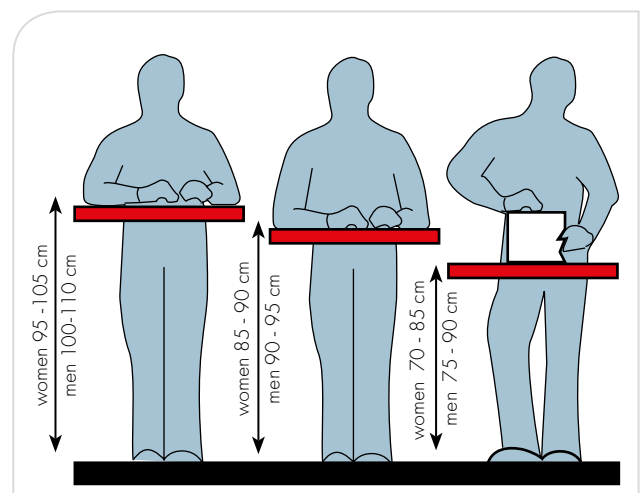

Standing work

Our standards comply with the highest certification requirements



<p>Quality certification</p> <p>ISO 9001 : 2015</p>	<p>Environmental Management System certification</p> <p>ISO 14001 : 2015</p>	<p>Packaging treatment following to EU directives.</p>	<p>ESD-approval certification</p> <p>Our ESD products fulfill the basic requirements of IEC 61340-5-1.</p>	<p>GS certification for lighting and TP workbench</p>
--	---	---	---	--

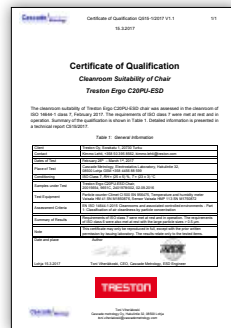

<p>Russian certificate of conformity</p>	<p>Russian certificate of conformity</p>	<p>Cleanroom Suitability of Treston Concept and WB Motorized Workstations</p> <p>ISO 14644-1, class 7</p>	<p>Cleanroom Suitability of Chair Treston Ergo C20PU-ESD</p> <p>ISO 14644-1, class 7</p>	<p>ESD certification</p> <p>Treston WB and Concept workstations fulfill the basic requirements of IEC 61340-5-1</p>
---	---	--	---	--

To obtain a copy of our certificates, please contact info@treston.com.

! The guarantee period for products manufactured by Treston is 5 years from the date of delivery; this excludes workbench tops, trade parts, electronic components, custom made articles and moving parts, for which there is a guarantee period of 2 years.





Decorating with colour

The working environment can be both attractive and inspirational. By choosing the colours of your equipment to match your corporate colours, you can reinforce your corporate image whilst creating a pleasant working environment.

Doors, drawers and perforated panels all come in various colours. The combination of different colours creates an interesting effect. Colours can also act as codes or identifiers.



Colour codes

Workbench, cabinet, shelving, drawer units and trolley frames are all light grey RAL 7035. Outside of the standard colour range, additional colours are available on request. Please contact our agents or email us at: sales@treston.com.

	Colour code	RAL code	Doors	Drawers	Perforated panels and back panels
Light grey	49* & 41**	RAL 7035 (ESD)	STD	A/STD	A/STD
Blue	07	RAL 5007	STD	A/STD	STD
Dark grey	45	RAL 7045	A	A	A
Red	25	RAL 3002	A	A	A

STD = Standard factory colour, normal warehouse delivery, listed price.

A = Factory colour, delivery 15 days from the factory, listed price.

* The products ordered with the colour code 49 (RAL 7035) are entirely ESD protected. Please note the ESD protection feature of these colours will result in a slightly darker shade of colour than the given RAL code.

**The frames of the products ordered with the colour code 41 (RAL 7035) are powder coated with a light grey ESD colour, but there are non-ESD parts in these products, such as shelves, rubber mats or castors.

STANDARD COLOURS

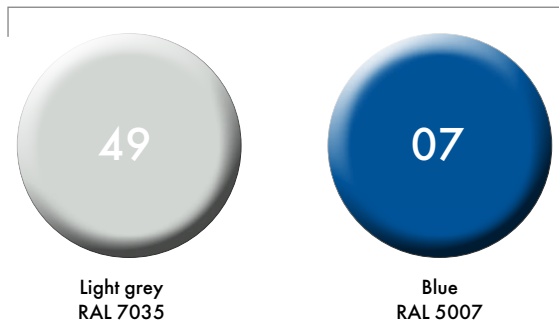

The colour code is included in those product codes that are formed with numbers.

It is either at the end, following the hyphen (e.g. 860 804-49), or in the middle (e.g. C 33407000).

FACTORY COLOURS

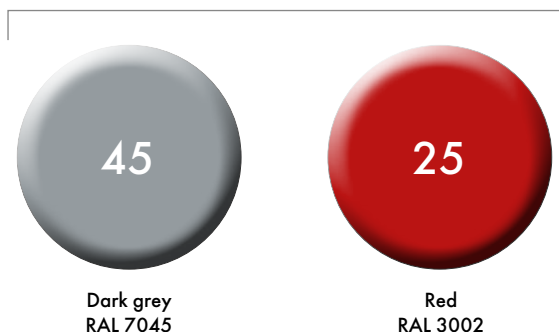

Printed colours do not give a fully accurate representation of painted colours. Please ask our agent about various samples.



Workbenches and accessories



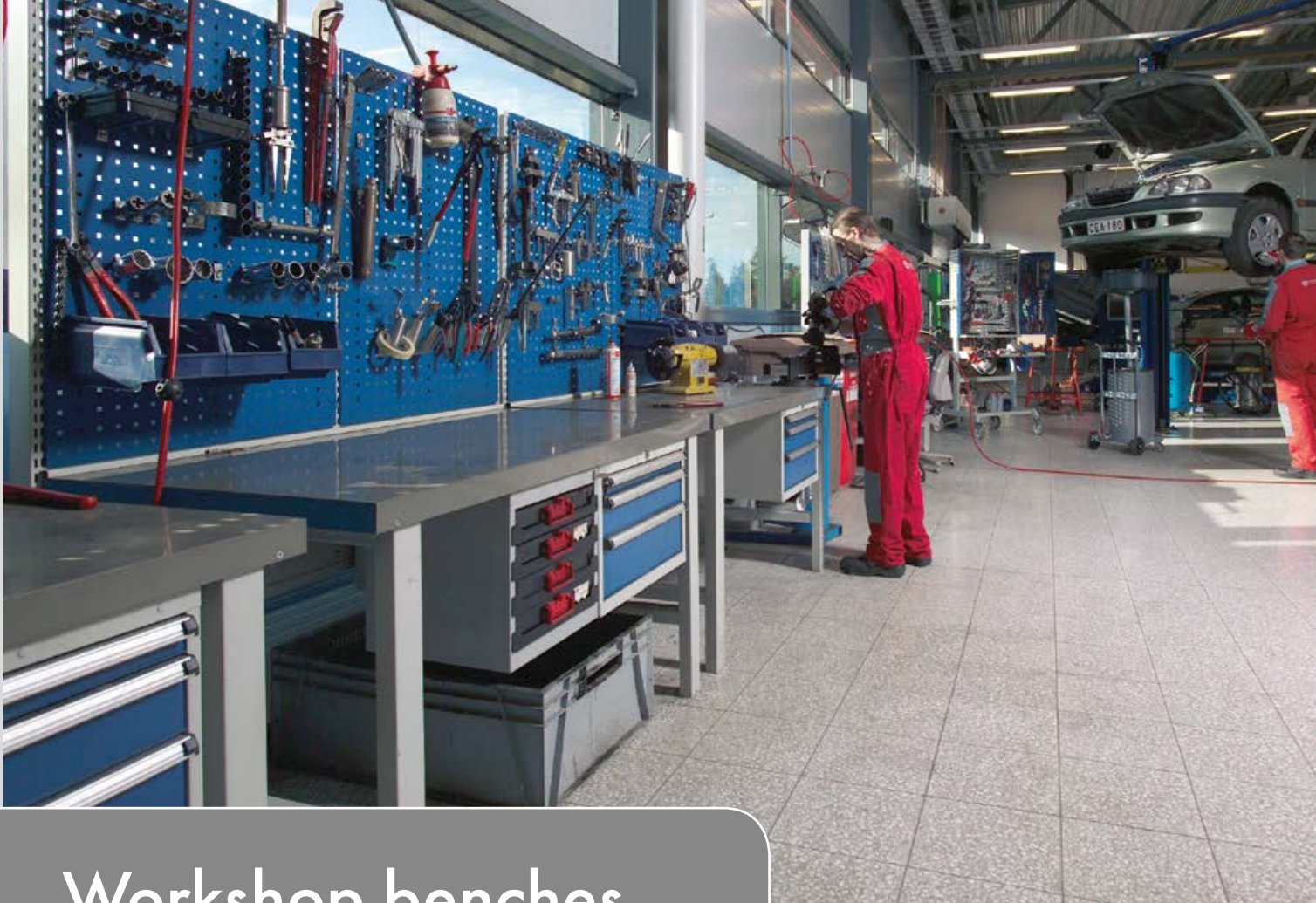

Workshop benches

'Workshop' benches are designed for the most demanding use and environments. Mechanical workshops, garages and heavy industry are environments where chemicals, heavy loads, and strenuous use necessitate robustness. These workbenches are very

durable and withstand the toughest conditions. There is a wide range of accessories available.

The Workshop bench is guaranteed for regular use with loads up to 750 kg.



- Worktop designed for very heavy loads, load capacity up to 750 kg.
- Very stable on uneven surfaces due to adjustable legs.
- Can be bolted to floor for more stability.
- You can build your personal workstation with our wide range of accessories.



A drawer unit can serve as a leg

Workshop workbenches can be easily extended by using a drawer frame or a leg as a common support for two workbenches.



This example includes

Qty	Name	Size mm	Code
2	Fixed leg		836 303-49
2	Steel bench top	1500 x 750	836 721-74
1	Drawer unit 55/66-1	550 x 715 x 800	612 07 201

Workshop bench examples



Workshop standard workbench

Qty	Name	Size mm	Code
2	Adjustable leg		836 664-49
1	Steel bench top	1500 x 750	836 721-74
1	Spacer bar	1500-2250	836 451-49



Workshop installation workstation

Qty	Name	Size mm	Code
2	Fixed leg		836 303-49
1	Wood top	1500 x 750	836 721-82
1	Drawer unit 55/13-1	550 x 715 x 130	610 07 001
1	Spacer bar	1500-2250	836 451-49



Workshop repair workstation

Qty	Name	Size mm	Code
2	Fixed leg		836 303-49
1	Steel bench top	1500 x 750	836 721-74
3	Upright tube	30 x 60 x 996	860 367-49
2	Perforated panel	718 x 612	861 512-07
1	Drawer unit 55/37-1	550 x 715 x 370	611 07 001
1	Fixing frame		860 375-49



Workshop workstation

Qty	Name	Size mm	Code
1	Steel bench top	1500 x 750	836 721-74
1	Adjustable leg	700-950	836 664-49
1	Fixing frame	1500	860 375-49
3	Upright tube	1359	860 024-49
1	Light/balancer rail	2 x M750	918 49 006
1	Treston NaturLite LED 1200	1180	TNL1200
2	Steel shelf	M750 x 300	836 028-49
2	Suspension rail	M750	859 151-49
5	Stacking bin		1525-5
7	Stacking bin		1015-5
1	Perforated tool cabinet	M750	852 629-07
1	Drawer unit 55/66		612 07 204



Design your own workstation

You can design your own workstation using the available components with the 3D configurator at <https://3d.treston.com>

Designing a Workshop workstation

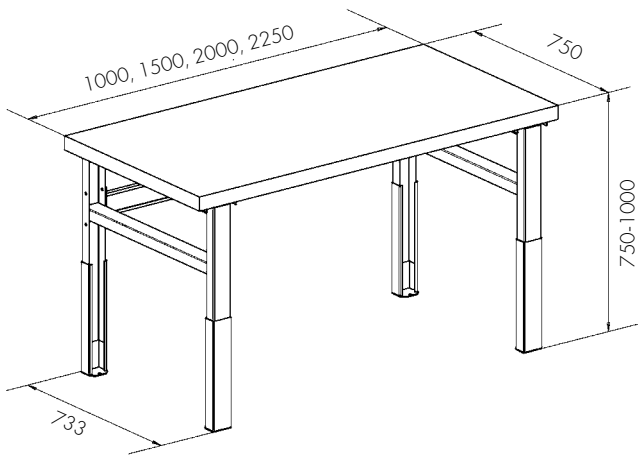

- Select the appropriate bench top: steel, vinyl or wood.
- Select a support for both ends of the bench top: adjustable or fixed leg or a drawer unit. Legs with castors are also available
- Use a spacer bar to stabilise the bench.
- An accessory frame can be used instead of a spacer bar if upright tubes are specified.
- Equip with accessories starting from page 24.



Workshop steel top

- Steel top 1.5 mm
- Epoxy powder coated dark-grey surface
- Grey plastic ends
- Plywood and chipboard core
- Threaded bushings for fixing legs and drawer units
- 3 mm steel top available on request
- Thickness 50 mm



Workshop top with steel edges

- Vinyl top
- Grey vinyl surface
- Galvanized steel front edge
- Plywood and chipboard core
- Threaded bushings for fixing legs and drawer units
- Thickness 50 mm

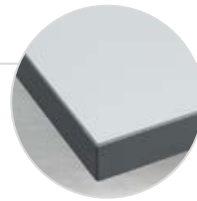

Workshop top with plastic edges

- Vinyl top
- Grey vinyl surface
- Grey plastic edging
- Plywood and chipboard core
- Threaded bushings for fixing legs and drawer units
- Thickness 50 mm



Workshop wooden top

- Beech multiplex, treated with linseed oil
- Pre-drilled holes for fixing legs and drawer units
- Thickness 40 mm

Workshop bench tops

Bench top Size W x D mm	Steel top 1,5 mm	Max load kg	Steel top 3 mm	Max load kg	Vinyl top with steel edges	Max load kg	Vinyl top with plastic edges	Max load kg	Wood top	Max load kg
1000 x 750	836 720-74	750	852 652-74	750	836 723-79	750	836 729-79	500	836 720-82	600
1500 x 750	836 721-74	750	852 653-74	750	836 724-79	750	836 726-79	500	836 721-82	600
2000 x 750	836 736-74	500	852 654-74	750	836 728-79	500	836 730-79	500	836 736-82	360
2250 x 750	836 722-74	500	852 649-74	750	836 725-79	500	836 727-79	500	836 722-82	360

Workshop legs

Name	Height mm*	Code
Adjustable H-leg (1 pc)	700-950	836 664-49
Fixed H-leg (1 pc)	800	836 303-49
Adjustable H-leg for castors (1 pc)	785-1000	836 029-49
Swivel castor with brake** (1 pc)	Ø160	900 041-00
Fixed castor** (1 pc)	Ø160	900 040-00

* Height without bench top (including 160 mm castors).

** Load capacity: 500 kg for benches 1000 mm and 1500 mm wide, 300 kg for benches 2000 mm and 2250 mm wide.



Legs with castors are also available

Spacer bar for Workshop bench

Spacer bar is used to stabilise the bench. It is necessary if the bench consists only of legs and bench top.

Width mm	Code
1000-1500	852 694-49
1500-2250	836 451-49



Accessory frame for Workshop bench

Accessory frame is needed if the bench is equipped with upright tubes. Replaces the spacer bar. See upright tubes and compatibility on page 24.

Width mm	Code
1000	852 693-49
1500	860 375-49
2000	860 725-49
2250	860 376-49



Accessories from page 24

There is a wide range of accessories available for Workshop bench.

Lower shelves for the Workshop bench

Not enough space above the workstation? Then utilise the space below. The lower shelf for Workshop bench simply hangs on the horizontal bars.

Name	Size W x D mm	Max load kg	Code
Lower shelf for adjustable leg for bench 1000	870 x 648	200	924 49 020
Lower shelf for fixed leg for bench 1000	870 x 648	200	924 49 021
Lower shelf for adjustable leg for bench 1500	1370 x 648	200	924 49 012
Lower shelf for fixed leg for bench 1500	1370 x 648	200	924 49 014
Lower shelf for adjustable leg for bench 2000	1870 x 648	100	924 49 013
Lower shelf for fixed leg for bench 2000	1870 x 648	100	924 49 015
Lower shelf for adjustable leg for bench 2250	2120 x 648	100	924 49 016
Lower shelf for fixed leg for bench 2250	2120 x 648	100	924 49 018

The lower shelves include a backstop.



The Workshop bench can be fitted with a lower shelf for bulky items.



Structure of the bench top

For us, the bench top is an important part of a bench's structure. For example, the Workshop bench top is designed for very heavy loads. Because of the bench top's structure, the bench is very sturdy, even with the highest loads. The feet and the drawers are attached to the threaded bushings in the bench tops.



TP and TPH workbenches

The classically designed TP workbench is the ideal basic bench, the simplest and the most cost-effective option in our range of workbenches. TP workbenches are standard benches that are suitable for a broad range of tasks and environments when fitted with accessories: testing, packing, repairing, inspecting. TP bench is guaranteed for regular use with loads up to 300 kg.

Designed for use in today's production and assembly environments, this definitive modular system, developed over more than 35 years, provides a high quality working environment. Customise your workstation to your own requirements.

Stepless height adjustment

The height of workbenches in our TP range can be steplessly adjusted from 650 to 900 mm, which makes these benches suitable for work while sitting or standing. Packing is a typical example of work where the workbench height must be set correctly for the height of the user.



- Standard and cost-effective workbench
- Suitable for a wide range of tasks and environments
- Easy to equip with a variety of accessories
- Steel frame with loading capacity up to 300 kg



TP workbench examples



TP workbench

Qty	Name	Size mm	Code
1	Workbench TP	1500 x 700	TP715
1	Accessory frame	1500	TPK15-49
1	Upright tube module	2 x M750	903 49 001P



TPH workbench

Qty	Name	Size mm	Code
1	Workbench TPH	1500 x 700	TPH715
1	Drawer unit 45/14, 1 x100 drawer		603 49 002



TP workbench

Qty	Name	Size mm	Code
1	Workbench TP	1500 x 700	TP715
1	Accessory frame	1500	TPK15-49
1	Upright tube module	2 x M750	903 49 002P
1	Light/balancer rail	2 x M750	918 49 006P
1	Treston NaturLite LED 1200	1180	TNL1200
2	Metal shelf	M750 x 300	836 028-49
2	Bin profile	M750	859 151-49
10	Stacking bin		1525-5



TPH workbench

Qty	Name	Size mm	Code
1	Workbench TPH	1500 x 700	TPH715
1	Tool and lighting support KT	1500 x 600	KT150
1	Extra C-profile SPR	1500	SPR150
1	Perforated panel RL	1415 x 750	RL150
1	Treston NaturLite LED 1200	1180	TNL1200

The TP bench can be equipped with castors!



Castor set Ø100, code 834 734 -00
Castor set Ø100 ESD, code 860 429 -00
Insert set (4 pcs - required to fit castors), code 853 289-00

Load capacity with castors 150 kg. We recommend using the fixing frame for the castors.

TP workbench

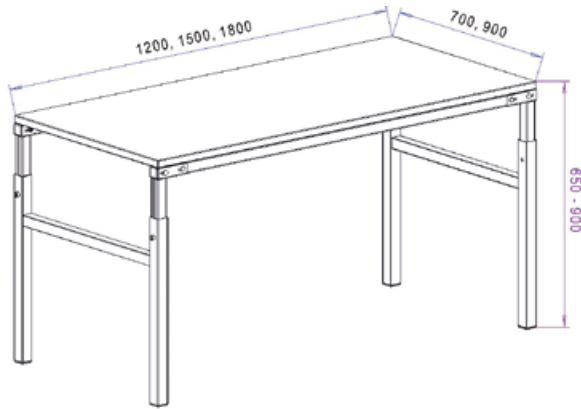

- Stepless height adjustment with allen-key between 650-900 mm.
- Frames are of epoxy powder coated steel in grey RAL 7035.
- Upright tubes (ordered separately) allow to attach a wide range of accessories.



Laminate bench top

- 25 mm low pressure laminate
- Light grey surface
- PVC edging

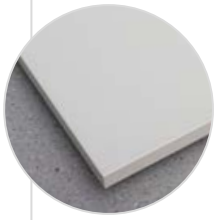

ESD bench top

- Light grey laminate surface
- Grey edging
- Thickness 25 mm
- Semi-conductive (ESD)

TP workbench

Bench size W x D mm	Max load kg	Code	Code ESD
700 x 500	150	TP507	TP507 ESD
1000 x 500	150	TP510	TP510 ESD
1500 x 500	150	TP515	TP515 ESD
1000 x 700	300	TP710	TP710 ESD
1200 x 700	300	TP712	TP712 ESD
1500 x 700	300	TP715	TP715 ESD
1800 x 700	300	TP718	TP718 ESD
1500 x 900	300	TP915	TP915 ESD
1800 x 900	300	TP918	TP918 ESD



The W x D x H rule

All our dimensions follow a WDH rule, where the first dimension is the width (W), the middle the depth (D), and the last the height (H).



Accessory frame for TP bench

Upright tubes or the upright tube module are always attached to the TP bench with an accessory frame. The accessory frame cannot be used on line or corner extensions.

Bench frame width mm	Fixing points for uprights	Code
1000	1 x M900	TPK10-49
1200	1 x M750, 1 x M900, 1 x M1200	TPK12-49
1500	1 x M1500, 2 x M750	TPK15-49
1800	1 x M1800, 2 x M900	TPK18-49



Accessories from page 24

TP bench with upright tubes can be equipped with the same accessories as Workshop bench.

Lower shelf for TP

Not enough space above the workstation? Then utilise the space below. The lower shelf for TP bench simply hangs on the horizontal bars.

Name	Size W x D mm	Max load kg	Code
Lower shelf	1080 x 500	50	AT120 TPH
Lower shelf	1380 x 500	50	AT150 TPH
Lower shelf	1680 x 500	50	AT180 TPH



The TP bench can be fitted with a lower shelf.



SAP trolley

Construction as TP bench. Height adjustment with allen key between 650-900 mm. Swivel castors (Ø 100 mm), two of which have brakes. Load capacity 150 kg. Lower shelf, extra shelf and push handle available separately.

Name	Size W x D mm	Max load kg	Code	Code ESD
Trolley	700 x 500	150	SAP507	SAP507 ESD
Trolley	1000 x 700	150	SAP710	SAP710 ESD
Trolley	1500 x 700	150	SAP715	SAP715 ESD
Lower shelf	700 x 500	40	AT507	AT507 ESD
Lower shelf	1000 x 700	40	AT710	AT710 ESD
Extra shelf*	700 x 500	40	LT507	LT507 ESD
Extra shelf*	1000 x 700	40	LT710	LT710 ESD
Handle	depth 500		PUSH50	PUSH50
Handle	depth 700		PUSH70	PUSH70

* Extra shelf for SAP trolley available 03/2020.



SAP trolley with AT lower shelf and PUSH handle.

TP extension benches



TP715

TP715 L



TP715

TP510 K



TP715*

TP707 KK

TP715*



* Workbench with one H-frame pair.

Line extension TP-L

Each standard TP bench may also be supplied as a line extension. Fitted to side of main bench.

Bench size W x D mm	Max load kg	Code	Code ESD
1000 x 700	150	TP710 L	TP710 L ESD
1200 x 700	150	TP712 L	TP712 L ESD
1500 x 700	150	TP715 L	TP715 L ESD
1800 x 700	150	TP718 L	TP718 L ESD
1500 x 900	150	TP915 L	TP915 L ESD
1800 x 900	150	TP918 L	TP918 L ESD

Angle extension TP-K

Each standard TP bench may also be supplied as an angle extension. Fitted to front angle of main bench.

Bench size W x D mm	Max load kg	Code	Code ESD
1000 x 500	150	TP510 K	TP510 K ESD
1200 x 700	150	TP712 K	TP712 K ESD

Corner workbench TP-KK

A corner workbench can be used with two TP benches (with one H-frame pair) to create a 90 °angle setup. TP KK unit consists of a worktop, two H-frames and a leg in the middle. Front side 565 mm.

Bench size W x D mm	Max load kg	Code	Code ESD
1100 x 1100	150	TP707 KK	TP707 KK ESD
1300 x 1300	150	TP909 KK	TP909 KK ESD

TPH workbench

The TPH workbench already includes a pair of uprights and one shelf; composing our best selling workstation set. It has its own range of accessories, also in stock, and covering the essential, basic needs of any professional workstation.

Height adjustment with allen-key between 650-900mm. Workbench with upright profiles and a laminate shelf. The shelf has a height adjustment between 1080-1550mm and a load capacity of 50kg. Construction as TP.



Workbench TPH

Bench size W x D mm	Shelf size W x D mm	Max load kg	Code	Code ESD
1200 x 700	1200 x 310	300	TPH712	TPH712 ESD
1500 x 700	1500 x 310	300	TPH715	TPH715 ESD
1800 x 700	1800 x 310	300	TPH718	TPH718 ESD
1500 x 900	1500 x 310	300	TPH915	TPH915 ESD
1800 x 900	1800 x 310	300	TPH918	TPH918 ESD



Accessories on page 30

There is a large range of workbench accessories available.



* Workbench with one H-frame pair.

Corner workbench TPH KK

A corner workbench can be used with two TPH benches (with one H-frame pair) to create a 90 °angle setup. TPH KK unit consists of a worktop, two H-frames and a leg in the middle. Front side 565 mm.

Bench size W x D mm	Max load kg	Code	Code ESD
1100 x 1100	150	TPH707 KK	TPH707 KK ESD
1300 x 1300	150	TPH909 KK	TPH909 KK ESD

Power channels for TPH

Dims mm	Suitable for	Code
Profile 1058	TPH712	TJK120
Profile 1358	TPH715/ 915	TJK150
Profile 1658	TPH718/ 918	TJK180
Includes 3 x E1, E2	TPH715/ 915	TJK150 SET
Includes 3 x E1, E2	TPH718/ 918	TJK180 SET

Double socket	E1
Switch	E2
Automatic fuse 10 A	E3
Automatic fuse/earth leakage switch 10 A/30 mA	E4
Emergency-stop-switch	E5
Data connector/shielded for Cat.6 cable	E6

The finished TJK 150 SET and TJK 180 SET include 3 double sockets (E1) and a switch (E2). (Other SETs are also available.)

Power channels for TPH

Constructed from aluminium profile, this range of compact power channels provides power distribution for TPH benches. Pre-assembled with a choice of components, ordered separately. The power channel is isolated from the workbench. 3 m cable is included. Aluminium profile 72 x 72 mm. All meet with CE requirements.



Power channel TJK



For UK energy rails please contact salesuk@treston.com for further details.

Accessories for Workshop and TP

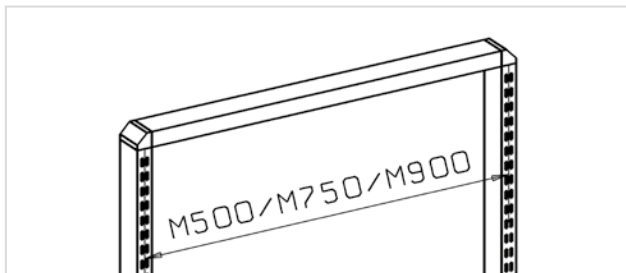

The modular (M) size refers to the distance between two upright tubes from the middle of the tube. The modular size is used to find the appropriate accessories.



Upright tube modules

For TP Bench we recommend using upright modules which include horizontal bars. This increases the stability of the uprights.

Upright tube modules for TP benches

	Suitable for bench widths			Code l=1359 mm	Code l=1582 mm
	1200	1500	1800		
1 x M750	TP			900 49 001P	900 49 002P
1 x M900	TP			901 49 001P	901 49 002P
2 x M750		TP		903 49 001P	903 49 002P
2 x M900			TP	904 49 001P	904 49 002P

Load capacity 100 kg / module spacing.

Upright tubes are the basic element for accessorising our industrial furnishings. Accessories are attached to TP and Workshop benches with the aid of upright tubes or a pre-assembled, upright tube module. The module includes upright tubes, horizontal tube(s), corner bracket pair and straight bracket (if module has more than one horizontal tube). The upright tubes or the upright tube module are attached to the back of the TP bench with accessory frame (ordered separately).

Upright tubes

Name	Size mm	Length (l) mm	Code
Upright tube	30 x 60	500	860 991-49
Upright tube	30 x 60	800	860 142-49
Upright tube	30 x 60	996	860 367-49
Upright tube	30 x 60	1359	860 024-49
Upright tube	30 x 60	1582	860 025-49
Upright tube pair*	30 x 30	1219	854 038-49

* Used in the service trolley (page 48).

Horizontal tube	M500	860 819-49
Horizontal tube	M750	847 402-49
Horizontal tube	M900	840 104-49

Corner bracket pair	848 336-49
Straight bracket	851 827-49

Upright tubes and compatibility

	Bench width					
	1000	1200	1500	1800	2000	2250
1 x M750	W	TP	W		W	W
1 x M900	W	TP	W		W	W
1 x M1000	W					
1 x M1200		TP				
1 x M1500			TP/W		W	W
1 x M1800				TP	W	W
2 x M500	W		W		W	W
2 x M750			TP/W		W	W
2 x M900				TP	W	W
2 x M1000					W	
3 x M500			W		W	W
3 x M750						W
4 x M500					W	

W = Workshop

Light and balancer rail

Apart from task lights all luminaires are fitted to light/balancer rails which are height and depth adjustable. Tool balancer rails and sliding hooks facilitate the use of heavy equipment. A tool balancer is fixed to the light/balancer rail.

Light and balancer rail (includes one sliding hook)

Modular size	Width of the front profile mm	Max load kg	Code
2 x M500	1000	15	918 49 001P
2 x M500/1500	1500	15	918 49 002P
4 x M500	2000	15	918 49 003P
M750	750	15	918 49 004P
M750/900	900	15	918 49 013P
M750/1500	1500	15	918 49 005P
2 x M750	1500	15	918 49 006P
3 x M750	2250	15	918 49 012P
M900	900	15	918 49 007P
2 x M900	1800	15	918 49 008P
M900/1500	1500	15	918 49 009P
M1200	1200	15	918 49 010P
M1350	1350	15	918 49 011P

With extension benches you also need a center bracket, code 860 074-49.

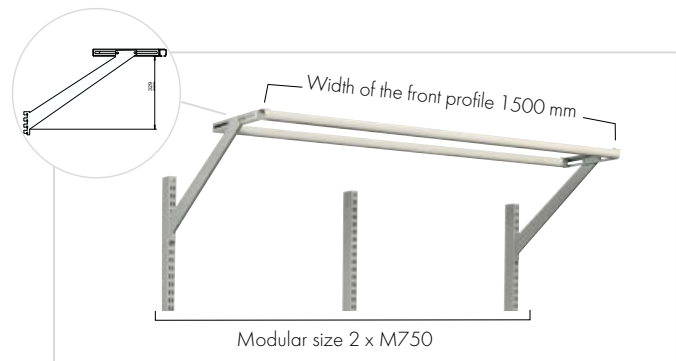
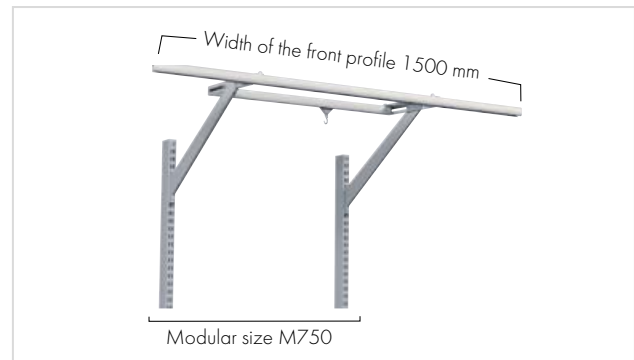

Tool balancers and other supplies

Name	Tool weight kg	Code
Tool balancer 2DU	0,5 - 1	939 502-00
Tool balancer 4DU	1 - 2	939 503-00
Sliding piece with a snap hook		890 557-51



Tool balancer



Sliding hook

Energy rails, distributor for compressed air

Energy rails (brackets for uprights included)

Width mm fixing	Code
1 440 8 sockets + on/off switch	910 51 001P
2 440 6 sockets + fault current protection	910 51 002P
3 M750 6 sockets + on/off switch	911 51 002P
M900 7 sockets + on/off switch	911 51 003P
Bracket pair for perforated panel	853 185-51

Energy rails are available in three module sizes: M500, M750 and M900 (440 mm wide model suites module size M500 horizontally).

Distributor for compressed air

Connections, Ø 8 mm	In	Out	Fixing	Code
4 Distributor for compressed air	1	2	vert.	859 861-00

Connectors are compatible with the CEJN 3200 series.

Can be fitted to all Treston benches.

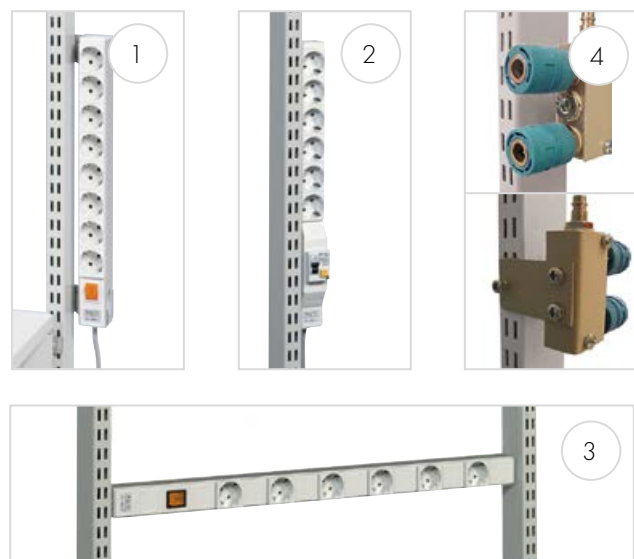

For UK energy rails please contact salesuk@treston.com for further details.



LCD-holder & keyboard tray



Document holder



Curved bin rail with arm



Extension for curved bin rail with arm



Tool panel

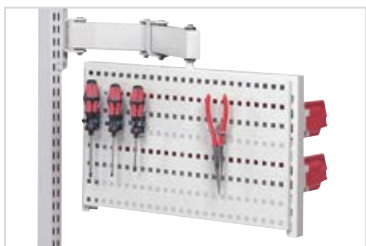

Rotating tool panel with perforated panel and R-hooks

Upright accessories

IT shelves and trays

Name	Size W x D mm	Max load kg	Code
LCD holder with double arm		15	930 49 002P
Keyboard tray for LCD holder	480 x 260	5	860 941-49
Keyboard and mouse tray for LCD holder	620 x 260	5	860 942-49

Document holders

Name	Size W x D mm	Max load kg	Code
Document holder A4	290 x 330	5	928 49 008P
Document holder A3	418 x 330	5	928 49 009P

Bin rails with arms

Name	Size W x D mm	Max load kg	Code
Curved bin rail with arm	770 x 54	15	929 49 002P
Extension for curved bin rail with arm	770 x 54		860 911-49

Tool panel

Name	Size W x D mm	Max load kg	Code
Tool panel	267 x 305	5	928 49 010P

Rotating tool panels

Name	Size W x D mm	Max load kg	Code
Rotating tool panel, height-adjustable arm	513 x 320	15	860 864-49P
Rotating tool panel, double arm	513 x 320	15	880 865-49P
Perforated panel	470 x 300		860 951-49
Tool trough M500	470 x 150		860 952-49
Suspension rail M500	492 x 90	50	859 150-49
Light suspension rail M500	492 x 54	10	860 953-49

Plastic boxes, hooks and tools in pictures are not included.



Rotating tool panel

The rotating tool panel can be equipped with perforated panels and tool troughs. The rotating tool panel is compatible with all M500 accessories, such as the tool trough and the suspension rails.

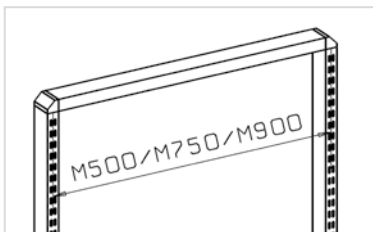
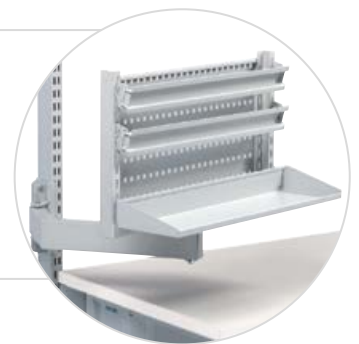

The modular (M) size refers to the distance between two upright tubes from the middle of the tube. The modular size is used to find the appropriate accessories.

Shelves

Shelves

Name	Module	Size W x D mm	Max load kg	Code
Steel shelf	M500	490 x 300	50	860 804-49
Steel shelf	M500	490 x 400	50	860 805-49
Tiltable top shelf	M500	467 x 300	80	TTSM5003-49
Tiltable top shelf	M500	467 x 400	80	TTSM5004-49
Steel shelf	M750	740 x 300	50	836 028-49
Steel shelf	M750	740 x 400	50	852 770-49
Tiltable top shelf	M750	717 x 300	80	TTSM7503-49
Tiltable top shelf	M750	717 x 400	80	TTSM7504-49
Steel shelf	M900	890 x 300	50	852 283-49
Steel shelf	M900	890 x 400	50	852 769-49
Tiltable top shelf	M900	870 x 300	80	TTSM9003-49
Tiltable top shelf	M900	870 x 400	80	TTSM9004-49
Tiltable top shelf	M1000	967 x 300	80	TTSM10003-49
Tiltable top shelf	M1000	967 x 400	80	TTSM10004-49
Tiltable top shelf	M1200	1167 x 300	80	TTSM12003-49
Tiltable top shelf	M1200	1167 x 400	80	TTSM12004-49
Tiltable top shelf	M1500	1467 x 300	80	TTSM15003-49
Tiltable top shelf	M1500	1467 x 400	80	TTSM15004-49
Tiltable top shelf	M1800	1773 x 300	80	TTSM18003-49
Tiltable top shelf	M1800	1773 x 400	80	TTSM18004-49



Steel shelf M500, M750, M900



Tiltable top shelf M500, M750, M900



Tiltable top shelf M1000, M1200, M1500, M1800

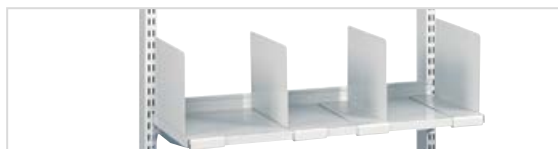

Divider pair

Divider pair for shelves M500, M750 and M900

Name	Size D x H mm	Code
Divider pair	285 x 190	010 004-49
Divider pair	385 x 190	010 005-49

Divider pair for shelves M1000, M1200, M1500 and M1800

Name	Size D x H mm	Code
Divider pair	285 x 190	861 116-49
Divider pair	385 x 190	861 118-49

Small storage solutions

Name	Module	Size W x D x H mm	Max load kg	Code
Perforated tool cabinet	M500	470 x 250 x 600	20	854 039-07
Perforated tool cabinet	M750	720 x 255 x 900	60	852 629-07
Shelf for M750 perforated tool cabinet		715 x 175 x 15	10	836 273-49
Personal safety equipment cabinet*	M750	720 x 330 x 900	60	860 987-07
File cabinet with two shelves	M750	720 x 330 x 900	60	860 980-49
PC/folder box, fitted to upright tube		130 x 290 x 330	5	860 983-49

* Includes energyrail with schuko plug and outlets.



Perforated tool cabinet



Personal safety equipment cabinet (includes energyrail with Schuko plug and outlets).



Sliding door cabinet



File cabinet with two shelves



PC/folder box

Stacking bins and shelf bins



Bin rail M750 with brackets and blue stacking bins.



Light bin rail M750 with brackets and red stacking bins.



Another way of ensuring an ergonomic working position and saving space is to use bin rails. The higher the rails are, the further they are from the workstation. To ensure an ergonomic working position, use the extension bracket pair on the higher rails. The bin rails are available in six standard module sizes.

Bin rails

Name	Suitable for module	Size W x D mm	Max load kg	Code
Bin rail	M500	492 x 100	50	859 150-49
Light bin rail *	M500	492 x 54	10	860 953-49
Bin rail	M750	742 x 100	50	859 151-49
Light bin rail *	M750	742 x 54	10	860 955-49
Bin rail	M900	895 x 100	50	859 152-49
Light bin rail *	M900	895 x 54	10	860 956-49
Bin rail	M1000	967 x 100	50	859 156-49
Bin rail	M1200	1167 x 100	50	859 157-49
Bin rail	M1350	1343 x 100	50	859 153-49
Bin rail	M1500	1493 x 100	50	859 154-49
Bin rail	M1800	1799 x 100	50	859 155-49
Extension bracket pair		60	50	860 919-49

* Suitable only for picking bins 30-1L, 30-2L and 30-23L.

Stacking bins

Our stacking bins have been designed for daily use in stores, production facilities and warehouses. These bins have been designed to fit all standard metric shelves and industrial workstations. Bins of the same width stack securely, even if they are of different depths. Straight sides ensure an efficient use of space.

Stacking bins

No.	Capacity l	Outer dims W x D x H mm	Inner dims W x D x H mm	Pack pcs	Code.* blue	Code.* red	Code.* ESD black	Labels and cross dividers		
								Labels + shields	Pack min. order	Cross divider
1.	0,6	105 x 165 x 75	90 x 105 x 65	60	1015-6	1015-5	1015-4 ESD	E10	60	
	2,7	149 x 250 x 130	125 x 185 x 115	30	1525-6	1525-5	1525-4 ESD	E15	30	V-14
	5,0	186 x 300 x 156	155 x 230 x 140	24	1930-6	1930-5	1930-4 ESD	E20	24	V-19
	7,2	186 x 400 x 156	155 x 330 x 140	24	1940-6	1940-5	1940-4 ESD	E20	24	V-19
2.	1,1	99 x 160 x 70	85 x 100 x 62	60	30-1L-6		30-1L-4 ESD			
	2,2	198 x 160 x 70	175 x 100 x 62	30	30-2L-6		30-2L-4 ESD			
	2,2	198 x 160 x 70	175 x 100 x 62	30	30-23L-6		30-23L-4 ESD			
										(2 fixed length dividers)

*) Code/one item. All bins are also available in grey colour (colour code -3).

Fixing stacking bins on the bin rail

Bin rail	M500	M750	M900	M1350	M1500	M1800	Curved bin rail
1015	4	7	8	12	14	17	
1525	3	5	6	9	10	12	
1930 & 1940	2	4	4	7	8	9	
30-1L	5	7	9	13	15	17	5
30-2L & 30-23L	2	3	4	7	7	9	



Shelf bins

Self bins are designed to fit all standard metric shelves, cabinets and industrial workstations.

Bins of the same width stack securely, even if they are of different depths. Straight sides ensure an efficient use of space, and the bins are available in several bright colours to facilitate product identification. Each drawer comes with a label and protective cover.



Shelf bins

Capacity l	Outer dims W x D x H mm	Inner dims W x D x H mm	Pack pcs	Code.*			Cross dividers	
				blue	red	ESD black	Code*	Number /bin
1,9	92 x 400 x 82	75 x 357 x 70	30	4010-6	4010-5	4010-4 ESD	D-10	6
2,4	92 x 500 x 82	75 x 457 x 70	30	5010-6	5010-5	5010-4 ESD	D-10	8
4,2	186 x 400 x 82	167 x 357 x 70	15	4020-6	4020-5	4020-4 ESD	D-20	6
5,3	186 x 500 x 82	167 x 457 x 70	15	5020-6	5020-5	5020-4 ESD	D-20	8
6,5	186 x 600 x 82	167 x 557 x 70	15	6020-6	6020-5	6020-4 ESD	D-20	10

*) Code/one items. All bins are also available in grey colour (colour code -3).



Accessories for TPH



Metal shelf TH



Bin profile BP



Auxiliary shelf SH



Perforated panel RL



Tool and lighting support KT



Swivel arm with tray CKV

Metal shelf TH

Size W x D mm	Max load kg	Suitable for	Code	Code ESD
1119 x 145	30	TPH712	TH120	TH120 ESD
1419 x 145	30	TPH715/915	TH150	TH150 ESD
1719 x 145	30	TPH718/918	TH180	TH180 ESD

Adjustment for depth, height and angle. For stacking and picking bins. Load capacity 30 kg.

Bin profile BP

Width mm	Max load kg	Suitable for	Code	Code ESD
profile 1115	15	TPH712	BP120	BP120 ESD
profile 1415	15	TPH715/915	BP150	BP150 ESD
profile 1715	15	TPH718/918	BP180	BP180 ESD

Aluminium profile for stacking and picking bins.

Auxiliary shelf SH

Size W x D mm	Max load kg	Suitable for	Code	Code ESD
1200 x 310	50	TPH712	SH120	SH120 ESD
1500 x 310	50	TPH715/915	SH150	SH150 ESD
1800 x 310	50	TPH718/918	SH180	SH180 ESD

Height adjustable shelf. 25 mm laminated particle board.

Perforated panel RL

Size W x H mm	Suitable for	Code	Code ESD
1115 x 750	TPH712	RL120	RL120
1415 x 750	TPH715/915	RL150	RL150
1715 x 750	TPH718/918	RL180	RL180
Panel hooks for TPH	TPH	RK1	RK1

Robust, perforated steel panel. 9 mm perforations at 38 mm centres. Mount on TPH-benches with connectors RK 1. Can also be attached to a wall with screws (included).

Tool and lighting support KT

	Size W x D mm	Suitable for	Code	Code ESD
	1200 x 600	TPH712	KT120	KT120
	1500 x 600	TPH715/915	KT150	KT150
	1800 x 600	TPH718/918	KT180	KT180
Extra C-profile	1500	KT150	SPR150	SPR150
Extra C-profile	1800	KT180	SPR180	SPR180

For suspending power tools and lighting units. Includes one C-profile bar with sliding hook.

Swivel arm with tray CKV

Size W x D mm	Max load kg	Suitable for	Code	Code ESD
Tray 210 x 460	15	TPH	CKV400	CKV400 ESD

Swivel arm with lockable, angle adjustable steel tray. Load 15 kg. Mount on C-profile.

Upright profiles HKCP

Height mm	Suitable for	Code	Code ESD
1470	TPH	HKCP147	HKCP147

If you mount both perforated panel RL and cable channel TJK to TPH benches, you must order extra-high upright profiles.

Component rack EPL

Size W x D x H mm	Suitable for	Shelves number	Code ESD
455 x 200 x 290	CKV	3	EPL12 ESD

Rack with three fixed shelves. Of semiconductive epoxy powder coated steel in light grey (RAL 7035).



Component rack EPL

Cable tidy TPHCT

Size W x D x H mm	Suitable for	Code	Code ESD
1115 x 45 x 205	TPH712	TPHCT120	TPHCT120
1415 x 45 x 205	TPH715/915	TPHCT150	TPHCT150
1715 x 45 x 205	TPH718/918	TPHCT180	TPHCT180

Mounted between C-profiles below worktop. Of perforated epoxy powder coated steel.



Cable tidy TPHCT

Cable clip set CC

Set	Max load kg	Suitable for	Code	Code ESD
5 pcs/set	15	TPH	CC12	CC12

The cable clip set will hold cables etc. securely and neatly in place along the bench frame. The clips locate in the 12 mm profile slot.



Cable clip set CC

PC stand CPU

Width mm	Height mm	Suitable for	Code
Vertical 130-240	395-500	TP/TPH benches	CPU
Horizontal 340-460			

An adjustable holder for either vertical or horizontal CPU, to mount underneath the bench worktop.



PC stand CPU

LCD bracket MH and LCD swivel arm MA and MA2

Max load kg	Suitable for	Code
15	TPH benches	MH
10	TPH benches	MA
15	TPH benches	MA2

The quick-release mechanism is equipped with the standard flat-screen mount 75 x 75 and 100 x 100 for the mounting of all normal flat-screens. Connector HKC-MA/MH needed for mounting LCD bracket MH to TPH benches, ordered separately.

MA and MA2 arms are double articulated, they turn through a radius of 180° and will extend between 95-425 mm from the upright. Connector HKC-MH/MA or HKC-MA2 needed for mounting LCD swivel arms to TPH benches.



LCD bracket MH

Connector HKC

Suitable for	Code
LCD bracket MH	HKC-MA/MH
LCD swivel arm MA	HKC-MA/MH
LCD swivel arm MA2	HKC-MA2

Connector HKC-MA/MH or HKC-MA2 is needed for mounting LCD bracket /swivel arm to TPH benches.



LCD swivel arm MA

Adapter set AS

Name	Suitable for	Code
Adapter set for upright profiles*	MH / MA / MA2	AS2
	MA3	AS3

* Concept/TP/LMT/Towerline upright tube profiles and TPH C-profile

The above adapter sets are needed for fixing MH/MA/MA2/MA3 arms to the uprights.



LCD swivel arm MA2

TRESTON

Lighting





Lighting ergonomics



Lighting is a vital part of ergonomic workspaces in industrial environments. Light allows people to see and perform tasks better as well as affecting their personal wellbeing and health.

Individually adjustable, natural workstation lighting means more productivity

Investing in individually controllable task lighting on workstations benefits both the employees and the employer. Employees feel more motivated as they can adjust brightness and preferably also colour tone to best suit themselves and the task at hand. This can lead to increased productivity, reduced errors and less absence, which normally affect the company's profitability.

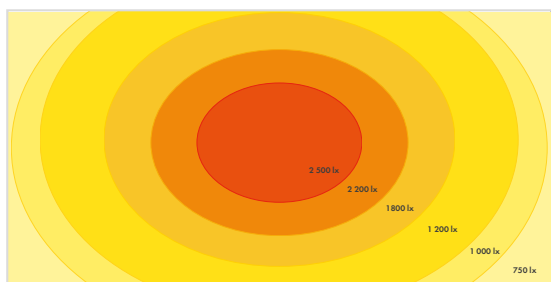

Graph of light Illuminance

Treston NaturLite LED 1200 Illuminance $\pm 10\%$ (@1 metre)

Lighting standard sets the expectations

When designing workstations and their lighting, we observe the recommendations of the EN 124641 standard on indoor workplace lighting. The illuminance levels set by standards are average values, but going beyond those is often reasonable. It is especially beneficial to increase the high-quality lighting for employees over 45 years old.

Optical ergonomics need attention

Optical ergonomics require the viewed object to be at a suitable distance and location, in order to maintain an acceptable amount of eye movement, ensuring that the details can be seen without problems. Also, adequate and glare-free lighting is important. When these conditions apply and the working position is well adjusted, saving time and money due to fewer absences and decreased stress can be expected.

Benefits of proper adjustable lighting in industrial environments include

- Increased productivity
- Reduced number of errors
- Decreased absenteeism
- Increased well-being of the employees

Treston NaturLite LED

Natural workstation lighting for industrial environments



Good, adjustable workstation lighting is essential for work quality and the well-being of employees. The right amount of light at the right time also enhances productivity and reduces errors in industrial environments.

Achieve your full potential with:

- Tunable colour tone
- Dimmable brightness
- Effective performance



Get all the specifications and download the brochure:
treston.com/catalogues-and-brochures



Treston NaturLite LED Plus 1200

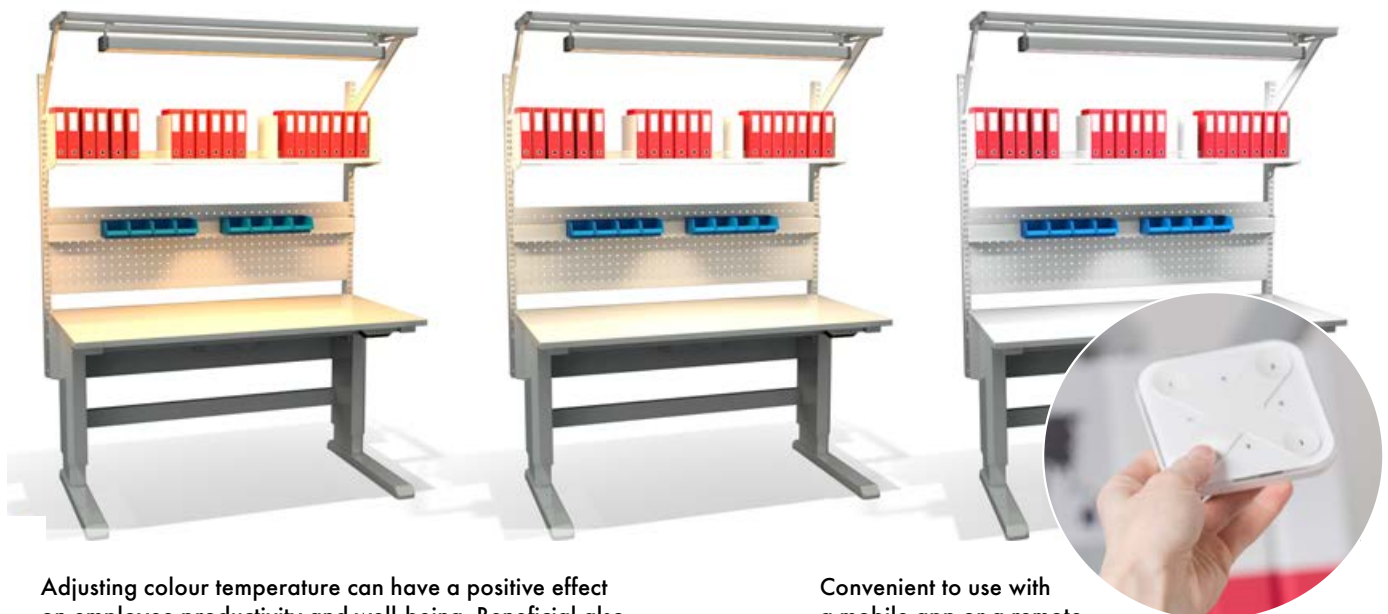

Adjusting colour temperature can have a positive effect on employee productivity and well-being. Beneficial also in environments where it is important to see objects in different light ranges.

Convenient to use with a mobile app or a remote control.

WATCH THIS ANIMATION and get the main facts of the Treston NaturLite LED lights in less than 2 minutes: <https://vimeo.com/241502723>



Dimmable
brightness

Treston's New Lighting Solution: Treston NaturLite LED



Treston NaturLite LED Plus 1200
Bright light with tunable colour tone



Treston NaturLite LED 900
Bright, dimmable light in smaller body

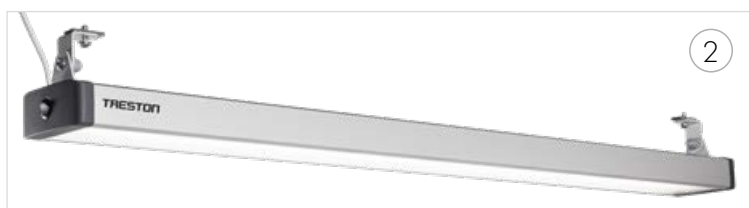

Treston NaturLite LED 1200
Bright light with full adjustability



Treston NaturLite LED Wing 500
Versatile task light

Name	Control	Colour temperature	Illuminance ±10% (@1 meter)	Luminous flux	Power	Size W x D x H mm	Suitability	Code
1. Treston NaturLite LED Plus 1200	Controlled via mobile app or separate remote control + ON/OFF button in the luminaire body	2700 - 6500 K	~4000 K: 2800 lx (1000 - 2800 lx depending on the colour temperature)	3200 - 6300 lm (depending on the selected colour temperature)	60 W	1180 x 120 x 50	All Treston and various other industrial workbenches	TNL1200P
Remote control for Treston NaturLite LED Plus 1200	Easy to use and save presets via mobile app. White.					90 x 90 x 12	Treston NaturLite LED Plus 1200	TNLPR
2. Treston NaturLite LED 1200	Touch dim button switch for ON/OFF and dimming in the luminaire body	4000 K	3100 lx	7100 lm	56 W	1180 x 120 x 50	All Treston and various other industrial workbenches	TNL1200
3. Treston NaturLite LED 900	Touch dim button switch for ON/OFF and dimming in the luminaire body	4000 K	2300 lx	5200 lm	42 W	900 x 120 x 50	All Treston and various other industrial workbenches	TNL900
4. Treston NaturLite LED Wing 500	Touch dim button switch for ON/OFF and dimming in the luminaire body	4000 K	800 lx	1750 lm	14 W	430 x 120 x 50 mm (+ bracket 95/120 mm)	Concept, WB, LMT and TP benches, Treston Tower, TPH and TPB benches*	TNL500W

Common features: Dimmable, Lifetime > 50 000 hours (L90B10), Color Rendering Index CRI > 80, High quality LED (MacAdams < 3) Aluminium body, 2 years guarantee, Enclosure protection IP20

* TPH and TPB benches require bracket 890 683-49



- ✓ Adjustability helps to find optimal lighting conditions.
- ✓ Timeless design brings functional beauty to industrial environments and it is never out of style.
- ✓ Easy and fast to install – just click, slide and screw.
- ✓ High-quality LED lights with high-quality drivers are care-free for years to come. Low maintenance, just keep them clean!



Treston NaturLite LED Wing 500

- ✓ Versatile task light
- ✓ Working area with or without shadows
- ✓ Also suitable in the middle of the table



WATCH THIS ANIMATION and get the main facts of the Treston NaturLite LED lights in less than 2 minutes: <https://vimeo.com/241502723>

CUTTING EDGE TECHNOLOGY

Tunable colour tone (2700-6500 K)

Dimmable 1/10-100%

Power 14-60 W (max)

Lean design

Illuminance 800-3100 lx
±10 % (1 meter)

2 years guarantee

Lifetime > 50 000 hours (L90B10)

Suitable for all Treston and various
other industrial workbenches

Color Rendering Index
CRI > 80

Enclosure protection IP20

High quality LED
(MacAdams < 3)



Chairs





High-performance industrial chairs with a 10 year warranty

The new Treston chair range offers high-performance seating solutions with maximum customer benefit for any industrial and technical working environment. Our high-quality technical products fulfill the highest requirements, offer outstanding value for money and meet the requirements of various workplaces – from production and packaging to standing work, ESD areas and R&D environments.

Industrial workplaces require industrial chairs

Ergonomically sound chair is a vital part of the well-functioning, ergonomic and user-friendly workstation. Good sitting enables effective and appropriate movements, reduces postural fixity and enables good and relaxed working postures. The ergonomic requirements of workplace chairs in industrial and technical environments are inherently different to those of other areas, such as office. The jobs carried out at manufacturing workstations may involve force, precision skills and repetitive movements, and thus the workplace chair must adapt perfectly to these tasks and working environments in order to support the workers – and their well-being- in the best possible way.

Six models with 24 variations

The new chair range consists of six different models: Multi-purpose Treston Ergo, Treston Plus with an all-inclusive ergonomic package, new generation workplace chair Neon with changeable upholsteries, Flex for standing work, Stool for assistance in workshops and Saddle chair for alternative way of sitting. In addition, there are three surfaces/upholsteries to choose from: a highly resistant polyurethane, comfortable fabric and easy-to-care artificial leather, making it is easy to find the most suitable chair for the working environment from our 24 chair variations.

Safe, sound and economic solution

Treston chairs ensure safety in the workplace by fulfilling the requirements of DIN 68877 and by carrying the GS safety mark, and in addition, our ESD chairs are in compliance with EN 61340-5-1. Besides being safe and ergonomic, our chair selection has a full 10 year warranty*. The Treston chair range is a safe, sustainable and economic solution for industrial seating.

* Saddle chairs 2 years



Find more information about ergonomic sitting from our separate brochure!
treston.com/catalogues-and-brochures



Treston Ergo

Multipurpose chair for almost any application in the industry

- User-friendly and quick adjustability
- Excellent price-performance ratio
- Large, ergonomically designed seat and backrest and lumbar support



Treston Plus

The all-inclusive ergonomic package

- Best possible adjustment to body size
- Supports the body in every position
- For any work situation



Neon

New generation workplace chair

- All the same adjustments and features as in Treston Plus
- In addition changeable upholstery and flex strip for protection of the chair and its environment



Flex standing rest

For best support in standing work and combined workplaces

- 360° rotation of the seat, easy height adjustment of foot ring
- Space saving
- Slip resistant seat



Stools

- Optimal assistance in workshop and heavy duty applications
- Adjustment for seat height



Saddle chairs

- Freedom of movement with ergonomic sitting position
- Adjustment for seat height and seat tilt





Treston Ergo chair with fabric upholstery

	Treston Ergo 30	Treston Ergo 30 ESD	Treston Ergo 35	Treston Ergo 35 ESD
Description	With soft dual-wheel safety castors (conductive with ESD versions) with load-sensitive brakes.		High version with foot ring and glides (conductive with ESD versions).	
Upholstery	The high-quality fabric upholstery is breathable and can both absorb and expel moisture.			
Code	C30BL	C30BL-ESD	C35BL	C35BL-ESD



Treston Ergo chair with artificial leather upholstery

	Treston Ergo 30 AL	Treston Ergo 30 AL ESD
Description	With soft dual-wheel safety castors (conductive with ESD versions) with load-sensitive brakes.	
Upholstery	Artificial leather upholstery is washable, resistant to disinfectants and easy to care.	
Code	C30AL	C30AL-ESD



Treston Ergo chair with polyurethane foam (PU)

	Treston Ergo 20 PU	Treston Ergo 20 PU ESD	Treston Ergo 25 PU	Treston Ergo 25 PU ESD
Description	With soft dual-wheel safety castors (conductive with ESD versions) with load-sensitive brakes.		High version with foot ring and glides (conductive with ESD versions).	
Upholstery	The PU surface is highly resistant, extremely robust, washable and very easy to clean.			
Code	C20PU	C20PU-ESD	C25PU	C25PU-ESD



Treston Plus chair with fabric or artificial leather upholstery

	Treston Plus 40 BL	Treston Plus 40 BL ESD	Treston Plus 40 AL	Treston Plus 40 AL ESD
Description	With soft dual-wheel safety castors (conductive with ESD versions) with load-sensitive brakes			
Upholstery	Black fabric	Black fabric ESD	Artificial leather	Artificial leather ESD
Code	C40BL	C40BL-ESD	C40AL	C40AL-ESD



Neon chair with fabric upholstery

	Neon 50 ESD
Description	With conductive soft dual-wheel safety castors with load-sensitive brakes.
Upholstery	Black fabric ESD, grey flex strip
Code	C50BL-G-ESD



Flex standing rest with polyurethane foam (PU)

	Flex 19	Flex 19 ESD
Description	High version with foot ring and glides (conductive with ESD versions).	
Upholstery	The PU surface is highly resistant, extremely robust, washable and very easy to clean.	
Code	C19PU	C19PU-ESD



Stool with polyurethane foam (PU) or artificial leather

	Stool PU	Stool AL-ESD
Description	With soft dual-wheel safety castors (conductive with ESD versions) with load-sensitive brakes	
Upholstery	Polyurethane PU	Artificial leather ESD
Code	C15PU	C15AL-ESD



Saddle chair with fabric or (artificial) leather upholstery

	Saddle B	Saddle G ESD	Saddle AL ANTIB	Saddle AL ESD	Saddle L
Description	With soft dual-wheel safety castors (conductive with ESD versions) with load-sensitive brakes				
Upholstery	Blue fabric	Grey fabric ESD	Antibacterial artificial leather	Artificial leather ESD	Leather
Code	SADDLE B	SADDLE G ESD	SADDLE AL ANTIB	SADDLE AL ESD	SADDLE L

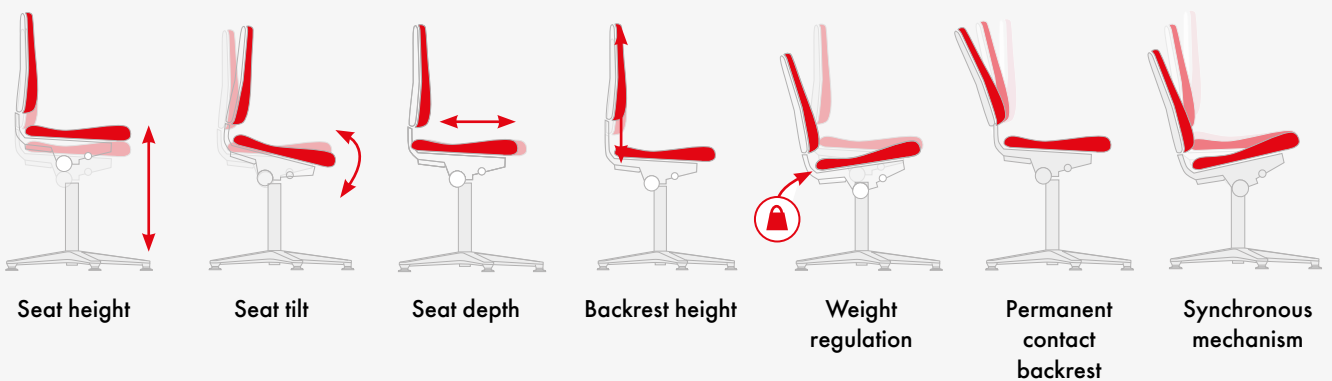

Adjustments and features	Treston Ergo	Treston Plus	Neon	Stool	Saddle chair	Flex – standing rest
Seat height	✓	✓	✓	✓	✓	✓
Seat tilt	✓	✓	✓		✓	
Seat depth		✓	✓			
Backrest height	✓	✓	✓			
Contact backrest	✓					
Synchro mechanism		✓	✓			
Arm rests as an option	✓	✓	✓			
Changeable upholstery			✓			

Code	Description / Upholstery / Colour	Martindale	Seat height, mm*	Seat width, mm	Seat depth, mm	Backrest height, mm	Weight, kg
Stools							
C15PU	Stool 15 polyurethane black		460-630	350	350		7,0
C15AL-ESD	Stool 15 artificial leather black ESD	50.000	460-630	400	400		8,0
Flex standing rests							
C19PU	Flex 19 polyurethane black		510-780	360	380	200	13,0
C19PU-ESD	Flex 19 polyurethane black ESD		510-780	360	380	200	13,0
Treston Ergo chairs							
C20PU	Treston Ergo 20 polyurethane black		440-620	440	410	380	11,5
C20PU-ESD	Treston Ergo 20 polyurethane black ESD		440-620	440	410	380	13,0
C25PU	Treston Ergo 25 polyurethane black		580-850	440	410	380	13,5
C25PU-ESD	Treston Ergo 25 polyurethane black ESD		580-850	440	410	380	15,0
C30AL	Treston Ergo 30 artificial leather black	50.000	440-620	460	470	460	12,0
C30AL-ESD	Treston Ergo 30 artificial leather black ESD	50.000	440-620	460	470	460	13,0
C30BL	Treston Ergo 30 fabric black	50.000	440-620	460	470	460	12,0
C30BL-ESD	Treston Ergo 30 fabric black ESD	40.000	440-620	460	470	460	13,0
C35BL	Treston Ergo 35 fabric black	50.000	580-850	460	470	460	14,0
C35BL-ESD	Treston Ergo 35 fabric black ESD	40.000	530-800	460	470	460	15,0
Treston Plus chairs							
C40AL	Treston Plus 40 artificial leather black	50.000	450-600	460	410-470	600	18,5
C40AL-ESD	Treston Plus 40 artificial leather black ESD	50.000	450-600	460	410-470	600	19,5
C40BL	Treston Plus 40 fabric black	50.000	450-600	460	410-470	600	18,5
C40BL-ESD	Treston Plus 40 fabric black ESD	40.000	450-600	460	410-470	600	19,5
Neon chairs							
C50BL-G-ESD	Neon 50 fabric black ESD grey strips	40.000	450-620	470	420-480	570	18,0
Saddle chairs							
SADDLE B	Saddle chair fabric blue	> 50.000	575-820	350	420		7,0
SADDLE G ESD	Saddle chair fabric grey ESD	> 50.000	575-820	350	420		7,0
SADDLE AL ANTIB	Saddle chair artificial leather ANTIB black		575-820	350	420		7,0
SADDLE AL ESD	Saddle chair artificial leather ESD black		575-820	350	420		7,0
SADDLE L	Saddle chair leather black		575-820	350	420		7,0

*According to the DIN 68877, the seat height is measured from the floor to the centre of the seat with a 64-kg load. The maximum load capacity of the chairs is 120 kg.

Accessories for chairs

Product	Description	Code	Code ESD
High glide set	Abrasion-resistant plastic glides have a large surface area and offer superb level of stability. The glides can be retrofitted to of all our chairs.	CGLIH	CGLIH-ESD
Soft castor set for hard floor	Dual-wheel safety castors are equipped with load-sensitive brakes, which means that the castors will brake when unloaded. As a standard, we supply soft castors for hard floors, but hard castors for soft floors need to be ordered separately.	CSCAS	CSCAS-ESD
Hard castor set for soft floor		CHCAS	CHCAS-ESD
Soft Stop&Go castor set for hard floors	In case the high chair needs to be moved around the workplace, Stop&Go castors will provide a safe solution. These castors will brake as soon as they are loaded, but when not loaded, the chair is easy to move around.	CSTOP	CSTOP-ESD
4D armrests for Treston Ergo and Treston Plus	Adjustment of height, width and depth with the possibility to swivel.	ARE	
4D ESD armrests for Treston Ergo ESD and Treston Plus ESD	Adjustment of height, width and depth with the possibility to swivel.		ARE-ESD
4D armrests for Neon	Adjustment of height, width and depth with the possibility to swivel.		ARN-ESD
Chrome-plated foot ring	Foot ring can also be retrofitted to our lower chair models by attaching it to the chair column. Can be used on both ESD and non-ESD models. The height can be easily adjusted without any tools.	CRING	CRING



Trolleys

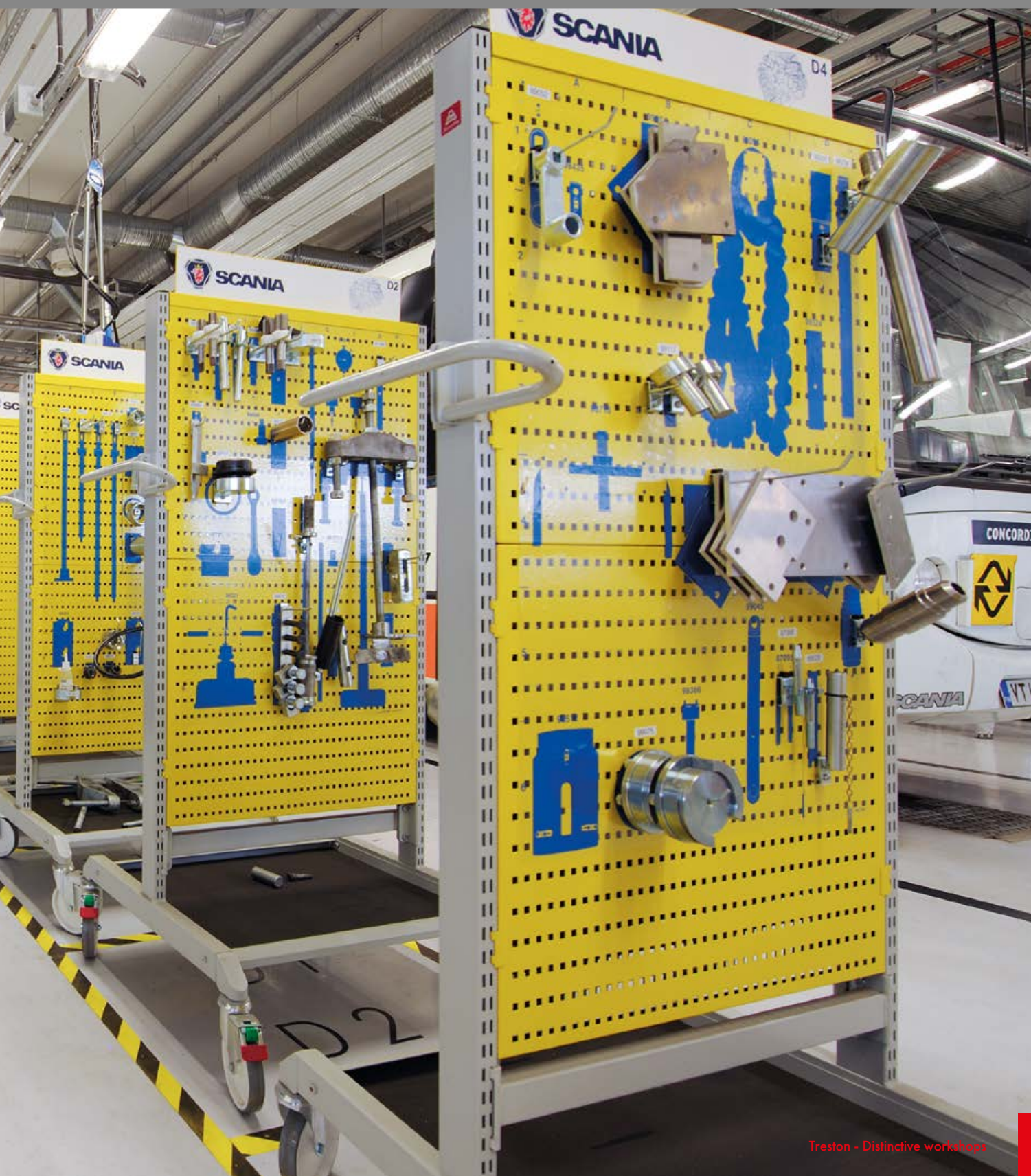



The castors are equipped with brakes to ensure your safety on uneven surfaces.

Freedom of mobility with trolleys

Increased productivity with mobility

Work is not always confined to a single workstation and tools must be moved around accordingly. Lightweight trolleys are ideal for this situation, significantly increasing productivity by up to 30%.

Each task is different and requires dedicated tools. Due to their modularity and versatile accessory components, trolleys are easy to customise and adapt to suit a multitude of users and applications.





Heavy-duty trolley

Heavy-duty trolleys, as their name indicates, are ideal for moving heavy loads. Their special castors support extremely heavy weights.



Fitter's trolley

A fitter's trolley lets you take your supplies and tools wherever you go, while keeping them organised. The rubber mat helps keep tools in place while you are working.



Service trolley

The service trolley frame is equipped with a safety locking feature that allows only one drawer to be opened at a time.



Basic trolley

Equip your trolleys with shelves, tops and other accessories to fit any application, such as transportation or tool storage.



Storage trolley

An easy solution for mobile storage, the storage trolley has an adjustable middle shelf, and the shelves are fitted with standard rubber mats.

Heavy-duty trolley



Heavy-duty trolleys, as their name indicates, are ideal for moving heavy loads. Their special castors support extremely heavy weights. The total capacity of the basic model is up to 600 kg!

The heavy-duty trolleys are equipped with two fixed castors (Ø 160 mm) and two swivel castors with brakes.

Heavy-duty trolley 3,
code C 750 07 103

Size 1000 x 810 x 1640 mm
Top 1000 x 750 mm
Worktop height 960 mm

For extremely heavy loads!

The total capacity of the basic heavy-duty trolley is up to 600 kg.



Heavy-duty trolley 1, code C 750 41 001



Heavy-duty trolley 2, code C 750 41 002



Heavy-duty trolley 4, code C 750 41 004
The cone bracket holder can hold up to 48 ISO cone brackets (cone bracket page 65).

Heavy-duty trolleys

Name	Size W x D x H mm	Max load kg	Code
Heavy-duty trolley 1	935 x 785 x 940	600	C 750 41 001
Heavy-duty trolley 2	935 x 785 x 940	600	C 750 41 002
Heavy-duty trolley 4	935 x 785 x 940	600	C 750 41 004

Heavy-duty trolley accessories

Name	Size W x D x H mm	Max load kg	Code
Shelf	812 x 770 x 30	400	852 671-49
Cone bracket holder, ISO	812 x 770 x 52	500	852 673-49

Heavy-duty trolley 3, code C 750 07 103

Qty	Name	Size mm	Code
1	Bottom shelf	933 x 780	852 666-49
1	Perforated uprights, pair	661	852 668-49
1	Perforated uprights, pair	1359	852 667-49
1	Cross support, pair		852 669-49
1	Handle		852 670-49
1	Pvc-top, steel edges	1000 x 750	836 723-79
1	Corner hooks		848 336-49
1	Horizontal tube M900	873	840 104-49
2	Fixed castors		900 040-00
2	Swivel castors		900 041-00
1	Perforated panel	870 x 389	861 516-49
1	Suspension rail M900	895	859 152-49
6	Plastic box 1525-5		1525-5
1	Fixing set		870 811-00
1	Drawer unit 55/37	550 x 715 x 370	611 07 001

Fitter's trolley

A fitter's trolley lets you take your supplies & tools wherever you go, while keeping them organised. The rubber mat helps keep tools in place while you are working. Version with drawer unit comes equipped with a safety lock that prevents other drawers from opening while one drawer is open. This helps to keep the trolley in balance - even with heavy loads.

The fitter's trolleys are equipped with four swivel castors (Ø 100 mm), two of which have brakes. Fitter's trolley can be combined with all M750 accessories.

Fitter's trolleys

Name	Module	Size W x D x H mm	Max load kg	Code
Fitter's trolley 1	M750	800 x 715 x 855	300	C 730 41 001
Fitter's trolley 2	M750	800 x 715 x 855	300	C 730 41 002
Fitter's trolley 3	M750	800 x 715 x 855	300	C 730 41 003
Fitter's trolley, frame	M750	800 x 715 x 855	300	C 730 41 000
Fitter's trolley 4		795 x 715 x 915	300	C 730 07 004

Fitter's trolley accessories

Name	Size W x D x H mm	Max load kg	Code
Bottom shelf with rubber mat	720 x 560 x 32	150	852 719-41
Bottom shelf with HDPE plastic covering	720 x 560 x 32	150	852 683-41
Shelf with rubber mat	720 x 560 x 32	150	852 720-41
Shelf with HDPE plastic covering	720 x 560 x 32	150	852 684-41
Extendable shelf + brackets	720 x 580 x 33	50	852 687-49

Fitter's trolleys can be combined with all M750 accessories.

Cone rack with hooks for tool holders HSK, Capto, ISO

Name	Size W x D x H mm	Max load kg	Code
Cone rack with hooks	742 x 188 x 90	50	854 430-49



Cone rack with hooks

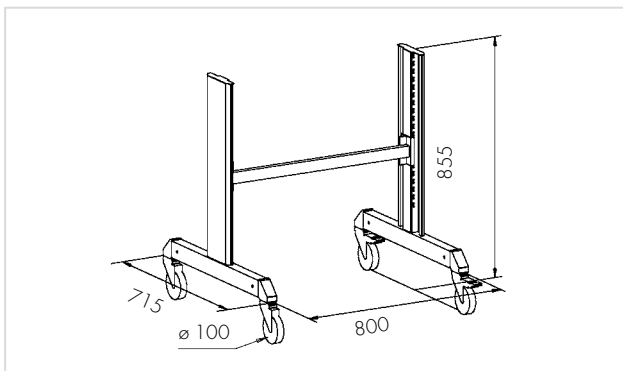

Fitter's trolley 1



Fitter's trolley 2



Fitter's trolley 3

Fitter's trolley 3 includes 6 cone racks. Tool brackets, page 69, ordered separately.



Fitter's trolley 4

Service trolley



Customise your service trolley with a selection of hooks from p. 98-100.

Service trolley
Size 710 x 480 x 875 mm
Max load 300 kg

The service trolley frame is equipped with a safety locking feature that allows only one drawer to be opened at a time. The cover comes as standard with a separate rubber mat that prevents items from slipping.

Both sides of the trolley have standard, perforated panels that you can accessorise with brackets and mountings, to suit any application. Service trolleys are also equipped with two fixed castors (Ø 150 mm) and two swivel castors including brakes (Ø 100 mm).

Service trolleys

Model	Service trolley 1	Service trolley 2	Service trolley 3	Service trolley 4	Service trolley 5	Service trolley 6	Service trolley 7	Service trolley 8
Code	710 07 001	710 07 002	710 07 003	710 07 004	710 07 005	710 07 006	710 07 007	710 07 008
Height (mm) of the drawer	3 x 75 	2 x 75 	1 x 75 	5 x 75 	2 x 75 	1 x 100 	1 x 100 	1 x 100
	1 x 125 	2 x 100 	4 x 100 	1 x 100 	2 x 100 	2 x 250 	2 x 125 	4 x 125
	1 x 250 	2 x 125 	1 x 125 	1 x 125 	1 x 250 		1 x 250 	

Internal drawer dimensions: 600 x 345 x 63/88/113/238 mm.



Accessorised service trolley

By attaching the upright tube pair 30 x 30 mm (code 854 038-49), you can use all the M500 accessories.

Accessories for service trolley (in the picture)

Qty	Name	Size mm	Code
1	Perforated upright pair	30 x 30 x 1219	854 038-49
1	Perforated tool cabinet	470 x 200 x 600	854 039-07
1	Suspension rail	M500	860 953-49
5	Plastic container		30-1L-6
1	Vice support		854 037-45
1	Pick-up box holder	165 x 48 x 456	854 042-49
4	Pick-up box	149 x 85 x 48	851 843-00
1	Utility box	155 x 90 x 410	854 041-49
1	Paper roll dispenser		854 043-49
1	Waste bucket holder		854 044-49
1	Waste bucket		839 159-00
1	Folder compartment	466 x 90 x 240	854 040-49



Drawer interiors for service trolley



Tool troughs 45 and 70 mm

Drawer 71/75 854 066-00



Middle dividers and plates 2

3 x middle divider, 6 x middle plate 150 and 2 x middle plate 300*

Drawer 71/75 854 069-49

Drawer 71/100 854 070-49

Drawer 71/125 854 070-49

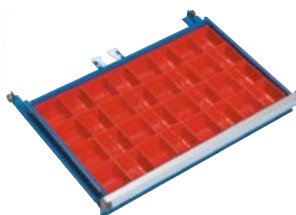

Pick up boxes

Drawer 71/75 854 064-00



Rubber mat for the drawer bottom

Rubber mat 71 854 078-00

* One example of interior solutions shown in picture.

Basic trolley



Basic trolley 1



Basic trolley 2



Basic trolley 3



Basic trolley 4



Basic trolley 5

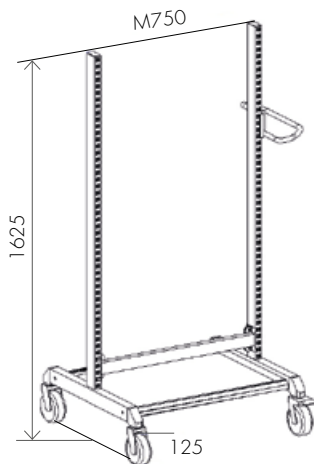

Basic trolley frame

Equip your trolleys with shelves, tops and other accessories to fit any application, such as transportation or tool storage.

All trolleys are equipped with four swivel castors (\varnothing 125 mm), two of which have brakes. The basic trolley can be combined with all the M750 accessories.

Basic trolleys

Name	Size W x D x H mm	Max load kg	Code
Basic trolley 1*	780 x 715 x 1630	300	BT-170B
Basic trolley 2	800 x 715 x 1625	350	C 740 07 102
Basic trolley 3	800 x 715 x 1625	350	C 740 41 003
Basic trolley 4	800 x 715 x 1625	350	C 740 07 004
Basic trolley 5	800 x 715 x 1625	350	C 740 41 105
Basic trolley frame**	800 x 715 x 1625	350	859 859-41

* Up to 112 stacking bins can be attached to one trolley, must be ordered separately.

** Basic trolley frame includes bottom shelf and rubber mat.

Basic trolley accessories

Name	Size W x D x H mm	Max load kg	Code
Bottom shelf with rubber mat	720 x 560 x 32	150	852 719-41
Bottom shelf with HDPE plastic covering	720 x 560 x 32	150	852 683-41
Shelf with rubber mat*	720 x 560 x 32	150	852 720-41
Shelf with HDPE plastic covering*	720 x 560 x 32	150	852 684-41
Steel shelf*	720 x 560 x 32	150	852 685-49
Steel shelf	720 x 560 x 32	150	852 665-49
Extendable shelf*	720 x 580 x 33	50	852 687-49
Wash basket L-300	380 x 302 x 110	20	839 116-51
Waste basket			839 159-00
Waste basket holder			835 773-49
Paper roll holder	Roll dimensions max: width 240 mm, \varnothing 230 mm)		860 310-49
Flow-through shelf*	718 x 835 x 61	150	890 710-49

Trolleys can be combined with all the M750 accessories. For perforated panels, see p. 88, for R-hooks, see p. 90.

*including brackets



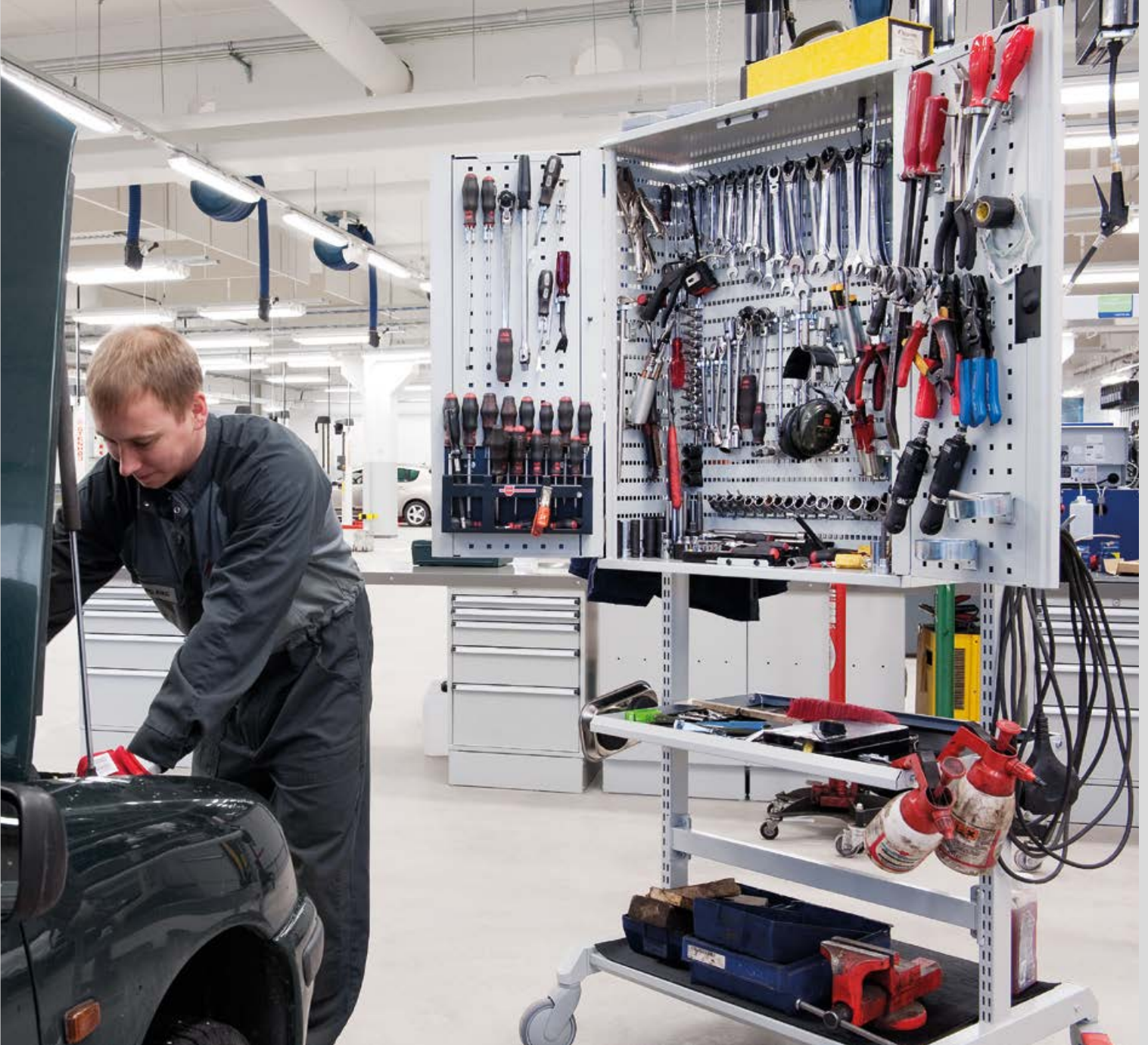

Storage trolley

An easy solution for mobile storage, the storage trolley has an adjustable middle shelf and the shelves are fitted with standard rubber mats.

The trolley is equipped with four swivel castors (Ø 100 mm), two of which have brakes.

Storage trolley

Name	Size W x D x H mm	Max load kg	Code	Code ESD
Storage trolley	650 x 450 x 775	3 x 30	852 773-41	852 773-49





Drawer units





Versatile drawer units

Since work is not always performed in the same place, we provide a comprehensive range of different drawer units for a variety of purposes. You can fix any drawer units from the same series under a worktop or on a base unit, or equip them with castors to take along to your next workstation.

Efficient storage and control

Our drawer units are great for storing tools and supplies. It can be surprising how much time is spent finding tools and other items if they are not stored systematically. The versatile interior combinations of our drawer units guarantee that your supplies are always at hand and in good order.

A comprehensive range of drawer units

We promise that you will find a drawer unit that meets your requirements in our comprehensive range. You can choose from several different heights, drawer sizes and interior combinations. We have selected some combinations for this brochure. For more options, please contact: sales@treston.com.

Drawer units for heavy loads

These robust drawer units are ideal for storing heavyweight supplies and tools, for example in a repair workshop or in the engineering industry.



Drawer unit 45/14 and 45/25



Drawer unit 55



Drawer unit 71



Drawer unit 70



Drawer unit 90



Drawer unit 130

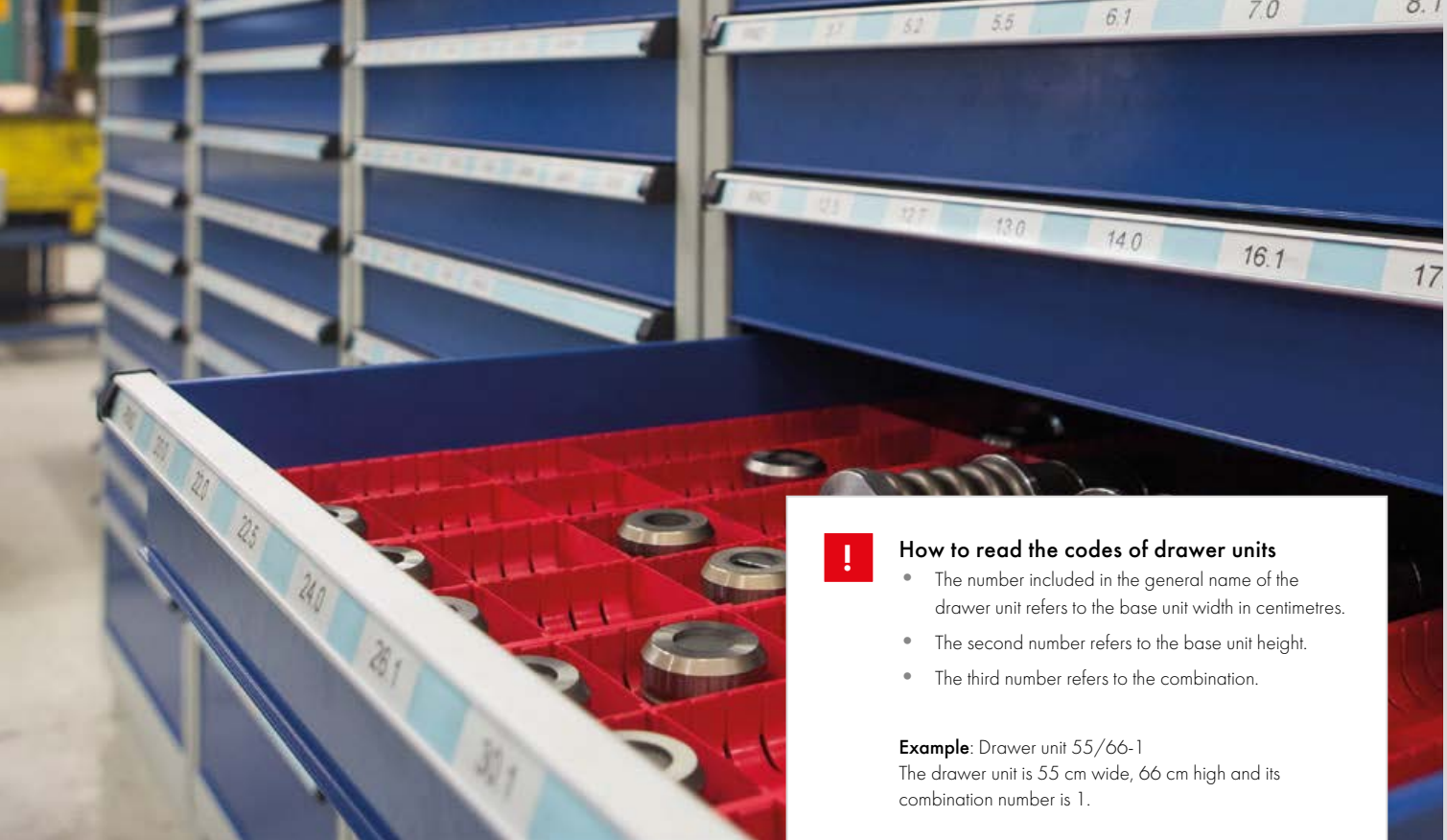

How to read the codes of drawer units

- The number included in the general name of the drawer unit refers to the base unit width in centimetres.
- The second number refers to the base unit height.
- The third number refers to the combination.

Example: Drawer unit 55/66-1

The drawer unit is 55 cm wide, 66 cm high and its combination number is 1.

Drawer unit 45/14 and 45/26

Drawer unit 45 is attached under the workbench. It comes with fully opening drawers.

Drawer units 45/14 and 45/26

Model	Opening	Load capacity kg / drawer	Outer dims W x D x H mm	Height (mm) of the drawer		Code
45/14-1	100%	60	450 x 520 x 140	1 x 100		603 49 001
45/26-1	100%	60	450 x 520 x 260	2 x 100		604 49 001

Internal drawer dimensions: 380 x 500 x 90 mm.

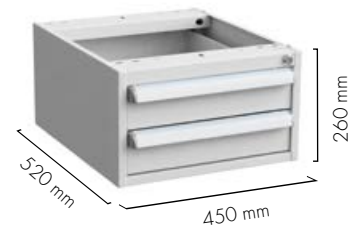

Drawer interiors

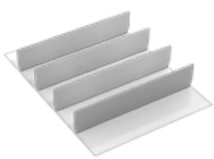

Divider set 1

Model	Code
Drawer 45/100	872 991-49
4 x horizontal dividers 375	



Divider set 2

Model	Code
Drawer 45/100	872 992-49
1 x vertical divider, 8 x divider plate 185	

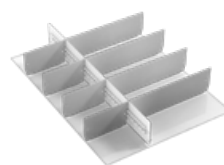

Divider set 3

Model	Code
Drawer 45/100	872 993-49
1 x vertical divider, 4 x divider plate 125, 4 x divider plate 250	



Divider set 4

Model	Code
Drawer 45/100	872 994-49
2 x vertical divider, 12 x divider plate 125	

Drawer unit 55

With these drawer units you can optimise your storage and keep all your items perfectly organised. The safety locking prevents other drawers from opening while one drawer is open (we recommend locking the drawers during transport). You can choose the best option from three heights to meet your needs, or add height or width with different drawer unit combinations.

66-cm-high drawer unit includes optional castors, making it an excellent choice for a mobile workstation. The unit with castors comes with a rubber mat that stops items from sliding on the surface. The version with doors is ideal for storing larger items. The 50 mm high drawer is fully extendable with a load capacity of 40 kg. The other drawers are 85% extendable with a load capacity of 80 kg.

The units also serve as workbench legs and the shallower drawers are easily fastened under a workbench. The

Choose the drawer unit according to your needs; with castors, base or no base.



Trolley model: load capacity 300 kg, 2 fixed castors, 2 swivel castors with brakes (ø 100 mm).























Drawer unit 55

















Model	55/13-1	55/37-1	55/37-2	55/37-3	55/37-4	55/37-5	55/37-6	55/37-7
Code	610 07 001	611 07 001	611 07 002	611 07 003	611 07 004	611 07 005	611 07 006	611 07 007
Height (mm) of the drawer	1 x 100	1 x 50 1 x 100 1 x 150	3 x 100	2 x 150	3 x 50 1 x 150	1 x 50 1 x 250	2 x 50 2 x 100	6 x 50





Internal drawer dimensions: 460 x 612 x 35/85/135/235 mm.



Drawer unit 55/66

	55/66-1	55/66-2	55/66-3	55/66-4	55/66-5	55/66-8	55/66-9	55/66-10
Standard	612 07 101	612 07 102	612 07 103	612 07 104	612 07 105	612 07 108	612 07 109	612 07 110
With base	612 07 201	612 07 202	612 07 203	612 07 204	612 07 205	612 07 208	612 07 209	612 07 210
With castors	612 07 301	612 07 302	612 07 303	612 07 304	612 07 305	612 07 308	612 07 309	612 07 310
Height (mm) of the drawer	3 x 50 	2 x 50 	1 x 50 	2 x 50 	1 x 50 	3 x 100 	2 x 100 	2 x 50 
	3 x 100 	2 x 100 	4 x 100 	1 x 100 	3 x 100 	2 x 150 	1 x 150 	5 x 100 
	1 x 150 	2 x 150 	1 x 150 	1 x 150 	1 x 250 		1 x 250 	
				1 x 250 				

	55/66-11	55/66-13	55/66-14	55/66-15	55/66-16	55/66-17	55/66-18	55/66-19
Standard	612 07 111	612 07 113	612 07 114	612 07 115	612 07 116	612 07 117	612 07 118	612 07 119
With base	612 07 211	612 07 213	612 07 214	612 07 215	612 07 216	612 07 217	612 07 218	612 07 219
With castors	612 07 311	612 07 313	612 07 314	612 07 315	612 07 316	612 07 317	612 07 318	612 07 319
Height (mm) of the drawer	1 x 100 	4 x 50 	4 x 150 	6 x 100 	1 x 50 	12 x 50 	5 x 50 	6 x 50 
	2 x 250 	1 x 100 			2 x 150 		1 x 100 	3 x 100 
		2 x 150 			1 x 250 		1 x 250 	

	55/66-20	55/66-21
Standard	612 07 120	612 07 121
With base	612 07 220	612 07 221
With castors	612 07 320	612 07 321
Height (mm) of the drawer	8 x 50 	2 x 50 
	2 x 100 	2 x 250 

Drawer unit 55/66-6 with door

	Door right	Door left
Standard	612 07 106	612 07 107
With base	612 07 206	612 07 207
With castors	612 07 306	612 07 307

Cabinets include bottom shelf.

Shelves for drawer unit 55/66 with door

Name	Size mm	Max load kg	Code
E-shelf	455 x 612 x 61	80	854 106-49
Shelf	540 x 629 x 35	80	854 114-49



Fastening set for drawer unit 55

Description	Code
Fastening set is needed for TP and TPH benches. Drawer unit 55 can be fastened on 900 mm deep TP and TPH benches.	855 056-49

Drawer interiors



Divider Set 1

55/100	873 001-49
55/150&250	873 006-49
3 dividers, 12 middleplates (9x100, 3x150)	



Divider Set 2

55/100	873 002-49
55/150&250	873 007-49
2 dividers, 9 middle plates (9x150)	



Divider Set 3

55/100	873 003-49
55/150&250	873 008-49
1 divider, 5 middle plates (3x150, 2x300)	

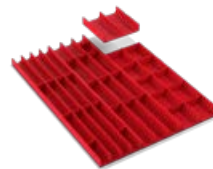

Tool troughs 33, 45 and 70 mm

Drawer 55/50	834 122-00
--------------	------------



Pick up boxes

Drawer 55/100	851 866-00
---------------	------------



Rubber mat for the drawer bottom

Rubber mat 55	852 717-00
---------------	------------

* One example of interior solutions shown in picture.

Drawer unit 55 combinations

It is possible to combine two drawer unit 55 frames with the help of a TWIN set (combination 3). The middle plate can be used to stack two drawer units 55 (combinations 1 and 2).



Combination 1, Code C 612 07 901

Includes	Code
55/66-4	612 07 304
55/37-1	611 07 001
Middle plate	854 103-49

Combination 2, Code C 612 07 902

Includes	Code
55/66-6	612 07 306
55/37-1	611 07 001
Middle plate	854 103-49
Shelf + brackets	854 114-49



Combination 3, Code C 612 07 903

Includes	Size mm	Code
55/66-4		612 07 104
55/66-6		612 07 106
Twin set		854 108-41
Shelf + brackets		854 114-49
Bench top	1200 x 750	110 995-79

TWIN set

Name	Size mm	Code
Twin set		854 108-41
Bench top	1200 x 750	110 995-79

The Twin set includes four swivel castors Ø100 mm, two of which have brakes and plates to fix two frames together. The top is not included in the pack.

Middle plate

Name	Code
Middle plate	854 103-49

Always remember
to lock the
drawer unit
during transport!

Drawer unit 71

Less than 50 cm deep, this drawer unit is ideal for use in narrow spaces, such as in vehicles. The units come with a rubber mat that stops items from sliding on the surface. The drawers have ball bearing runners and safety locking which prevents other drawers from opening

while one drawer is open.

This same drawer unit is used in the service trolley with castors p. 48. The drawers are 90% extendable and their load capacity is 50 kg.

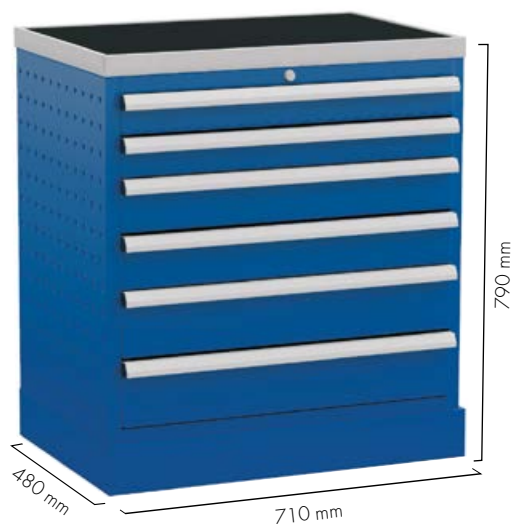

Drawer unit 71/79

Model	71/79-1	71/79-2	71/79-3	71/79-4	71/79-5	71/79-6	71/79-7	71/79-8
Code	620 07 001	620 07 002	620 07 003	620 07 004	620 07 005	620 07 006	620 07 007	620 07 008
Height (mm) of the drawer	3 x 75 	2 x 75 	1 x 75 	5 x 75 	2 x 75 	1 x 100 	1 x 100 	1 x 100
	1 x 125 	2 x 100 	4 x 100 	1 x 100 	2 x 100 	2 x 250 	2 x 125 	4 x 125
	1 x 250 	2 x 125 	1 x 125 	1 x 125 	1 x 250 		1 x 250 	

Internal drawer dimensions: 600 x 345 x 63/88/113/238 mm.

Drawer interiors



Tool troughs 45 and 70 mm

Drawer 71/75 854 066-00

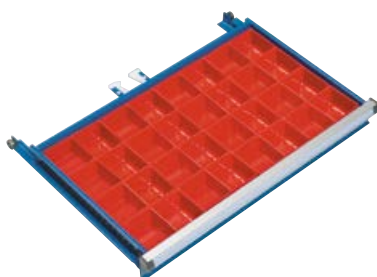

Pick up boxes

Drawer 71/75 854 064-00



Middle dividers and plates 2

3 x middle divider, 6 x middle plate 150 and 2 x middle plate 300*

Drawer 71/75 854 069-49

Drawer 71/100 854 070-49

Drawer 71/125 854 070-49



Rubber mat for the drawer bottom

Rubber mat 71 854 078-00

* One example of interior solutions shown in picture.

Drawer units 70, 90 and 130

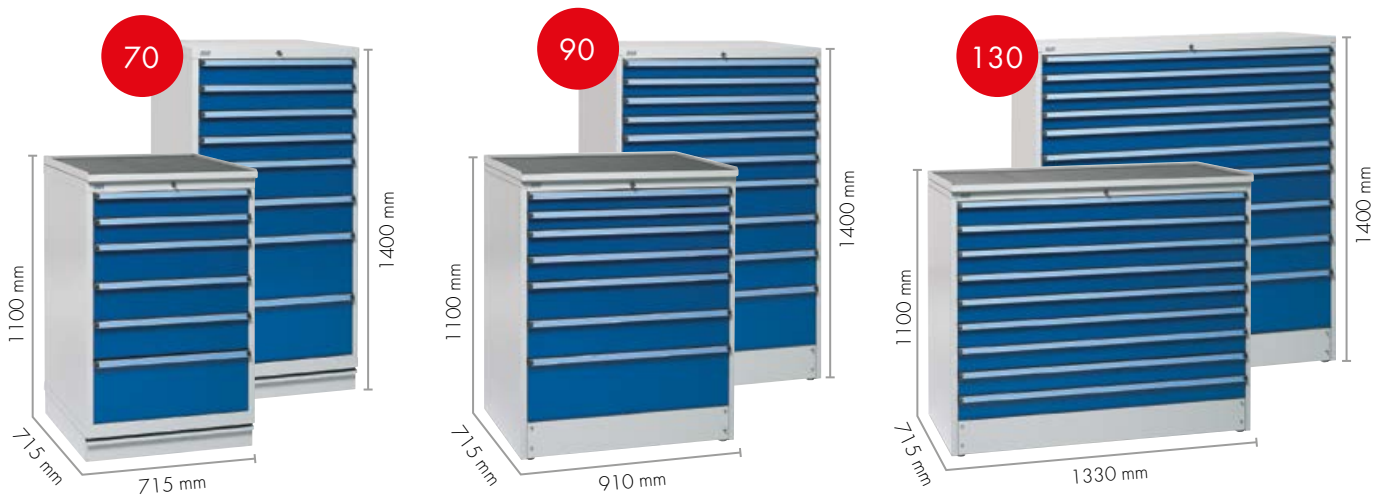

You can fit an amazing number of things in these spacious drawer units. Choose the one that best meets your needs from two heights: 110 and 140 cm. The 110-cm-high drawer units include a cover that doubles as a worktop with a rubber mat. This is the ideal height for working standing up.

The safety locking prevents other drawers from opening while one drawer is open. The drawer unit can be moved with a pallet truck or a forklift when the base front plate has been removed. The drawers are 100% extendable and their load capacity is up to 200 kg.

NEW: All the drawers are 100% extendable, also available with a load capacity of up to 200 kg!

The drawer units 70, 90 and 130 have been updated; all the drawers are now 100% extendable. The load capacity of the standard drawers is 75 kg, but all the drawer units are available with drawers that have **a load capacity of up to 200 kg!**

The drawer units with the load capacity of 200 kg are indicated by a product code having an H in the end (e.g. 613 07 001 H).



Drawer unit 70



Drawers open 100% and their load capacity is 75 kg / 200 kg.

The drawer units 70, 90 and 130 can be moved with a pallet truck or a forklift when the base front plate has been removed.

Drawer unit 70/110, 100% opening























Model	70/110-1	70/110-2	70/110-3	70/110-4	70/110-5	70/110-6	70/110-7	70/110-8
Code (75 kg)	613 07 001	613 07 002	613 07 003	613 07 004	613 07 005	613 07 006	613 07 007	613 07 008
Code (200 kg)*	613 07 001 H	613 07 002 H	613 07 003 H	613 07 004 H	613 07 005 H	613 07 006 H	613 07 007 H	613 07 008 H
Height (mm) of the drawer	2 x 100 	2 x 75 	9 x 100 	2 x 75 	2 x 50 	2 x 50 	3 x 50 	2 x 50
	3 x 150 	3 x 100 		2 x 100 	1 x 100 	4 x 100 	4 x 75 	2 x 75
	1 x 250 	3 x 150 		2 x 150 	3 x 150 	1 x 150 	2 x 100 	1 x 100
				1 x 250 	1 x 250 	1 x 250 	1 x 250 	2 x 150
								1 x 250

* Note! 50 mm high drawers always have a load capacity of 75 kg.





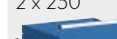

















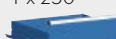

Model	70/110-9	70/110-10	70/110-11	70/110-12	70/110-13	70/110-14	70/110-15	70/110-16
Code (75 kg)	613 07 009	613 07 010	613 07 011	613 07 012	613 07 013	613 07 014	613 07 015	613 07 016
Code (200 kg)*	613 07 009 H	613 07 010 H	613 07 011 H	613 07 012 H	613 07 013 H	613 07 014 H	613 07 015 H	613 07 016 H
Height (mm) of the drawer	2 x 50 	2 x 50 	2 x 50 	2 x 75 	6 x 100 	2 x 50 	3 x 50 	1 x 50
	3 x 75 	3 x 75 	4 x 75 	6 x 100 	2 x 150 	5 x 100 	3 x 100 	1 x 100
	2 x 100 	1 x 125 	5 x 100 	1 x 150 		2 x 150 	3 x 150 	6 x 125
	3 x 125 	1 x 150 						

* Note! 50 mm high drawers always have a load capacity of 75 kg.























Drawer unit 70/110, 100% opening

Model	70/110-17	70/110-18	70/110-19	70/110-20	70/110-21	70/110-22	70/110-23	70/110-24
Code (75 kg)	613 07 017	613 07 018	613 07 019	613 07 020	613 07 021	613 07 022	613 07 023	613 07 024
Code (200 kg)*	613 07 017 H	613 07 018 H	613 07 019 H	613 07 020 H	613 07 021 H	613 07 022 H	613 07 023 H	613 07 024 H
Height (mm) of the drawer	6 x 125  1 x 150 	3 x 75  4 x 100  1 x 125  1 x 150 	2 x 50  2 x 75  2 x 100  3 x 150 	8 x 75  3 x 100 	1 x 150  3 x 250 	2 x 50  4 x 75  2 x 250 	1 x 50  2 x 75  2 x 100  2 x 250 	12 x 50  4 x 75 











* Note! 50 mm high drawers always have a load capacity of 75 kg.

Model	70/110-25	70/110-26	70/110-27	70/110-28	70/110-29	70/110-30	70/110-31	70/110-32
Code (75 kg)	613 07 025	613 07 026	613 07 027	613 07 028	613 07 029	613 07 030	613 07 031	613 07 032
Code (200 kg)*	613 07 025 H	613 07 026 H	613 07 027 H	613 07 028 H	613 07 029 H	613 07 030 H	613 07 031 H	613 07 032 H
Height (mm) of the drawer	1 x 50  4 x 150  1 x 250 	1 x 50  2 x 100  1 x 150  2 x 250 	2 x 50  4 x 75  4 x 125 	15 x 50  2 x 75 	1 x 50  2 x 75  3 x 100  1 x 150  1 x 250 	3 x 50  2 x 75  2 x 100  1 x 150  1 x 250 	6 x 50  8 x 75 	12 x 75 



























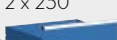

* Note! 50 mm high drawers always have a load capacity of 75 kg.

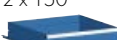
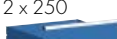
Model	70/110-33	70/110-34	70/110-36	70/110-37	70/110-38	70/110-39	70/110-40	70/110-41
Code (75 kg)	613 07 033	613 07 034	613 07 036	613 07 037	613 07 038	613 07 039	613 07 040	613 07 041
Code (200 kg)*	613 07 033 H	613 07 034 H	613 07 036 H	613 07 037 H	613 07 038 H	613 07 039 H	613 07 040 H	613 07 041 H
Height (mm) of the drawer	1 x 100  2 x 150  2 x 250 	6 x 150 	14 x 50  2 x 100 	1 x 50  2 x 75  7 x 100 	1 x 50  6 x 75  1 x 100  2 x 150 	2 x 50  2 x 150  2 x 250 	5 x 50  6 x 75  2 x 100 	8 x 50  4 x 75  2 x 100 



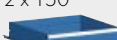
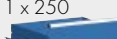























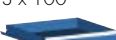

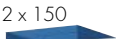
* Note! 50 mm high drawers always have a load capacity of 75 kg.

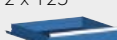
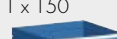
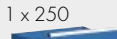
Model	70/110-42	70/110-43	70/110-44	70/110-45	70/110-46	
Code (75 kg)	613 07 042	613 07 043	613 07 044	613 07 045	613 07 046	
Code (200 kg)	613 07 042 H	613 07 043 H	613 07 044 H	613 07 045 H	613 07 046 H	
Height (mm) of the drawer	2 x 75  5 x 100  2 x 125 	2 x 75  3 x 250 	3 x 100  4 x 150 	4 x 100  2 x 250 	8 x 75  2 x 150 	





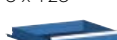















Drawer unit 70/140, 100% opening

Model	70/140-1	70/140-2	70/140-3	70/140-4	70/140-5	70/140-6	70/140-7	70/140-8
Code (75 kg)	616 07 001	616 07 002	616 07 003	616 07 004	616 07 005	616 07 006	616 07 007	616 07 008
Code (200 kg)*	616 07 001 H	616 07 002 H	616 07 003 H	616 07 004 H	616 07 005 H	616 07 006 H	616 07 007 H	616 07 008 H
Height (mm) of the drawer	2 x 75  5 x 100  2 x 150  1 x 250 	2 x 75  6 x 100  3 x 150 	4 x 100  2 x 150  2 x 250 	4 x 75  2 x 100  3 x 150  1 x 250 	2 x 50  3 x 100  2 x 150  2 x 250 	1 x 50  2 x 75  2 x 100  2 x 150  2 x 250 	1 x 50  4 x 75  3 x 100  2 x 150  1 x 250 	1 x 50  2 x 100  3 x 150  2 x 250 

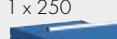





















* Note! 50 mm high drawers always have a load capacity of 75 kg.

Model	70/140-9	70/140-10	70/140-11	70/140-12	70/140-13	70/140-14	70/140-15	70/140-16
Code (75 kg)	616 07 009	616 07 010	616 07 011	616 07 012	616 07 013	616 07 014	616 07 015	616 07 016
Code (200 kg)*	616 07 009 H	616 07 010 H	616 07 011 H	616 07 012 H	616 07 013 H	616 07 014 H	616 07 015 H	616 07 016 H
Height (mm) of the drawer	4 x 50  2 x 75  3 x 100  2 x 150  1 x 250 	3 x 50  2 x 75  2 x 100  2 x 125  3 x 150 	2 x 50  4 x 75  4 x 100  1 x 150  1 x 250 	1 x 50  4 x 75  3 x 100  2 x 125  2 x 150 	6 x 75  1 x 100  2 x 125  1 x 150  1 x 250 	6 x 100  4 x 150 	12 x 50  8 x 75 	1 x 50  2 x 75  6 x 125  1 x 250 

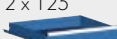
* Note! 50 mm high drawers always have a load capacity of 75 kg.















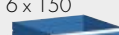
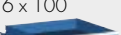

Model	70/140-17	70/140-18	70/140-19	70/140-20	70/140-21	70/140-22	70/140-23	70/140-24
Code (75 kg)	616 07 017	616 07 018	616 07 019	616 07 020	616 07 021	616 07 022	616 07 023	616 07 024
Code (200 kg)*	616 07 017 H	616 07 018 H	616 07 019 H	616 07 020 H	616 07 021 H		616 07 023 H	616 07 024 H
Height (mm) of the drawer	1 x 50  1 x 150  4 x 250 	1 x 50  12 x 75  1 x 100  1 x 150 	16 x 75 	3 x 100  6 x 150 	1 x 50  2 x 75  3 x 100  3 x 150  1 x 250 	24 x 50 	8 x 100  1 x 150  1 x 250 	12 x 100 

* Note! 50 mm high drawers always have a load capacity of 75 kg.

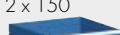
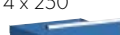
Model	70/140-25	70/140-26	70/140-27	70/140-28	70/140-29	70/140-30	70/140-31
Code (75 kg)	616 07 025	616 07 026	616 07 027	616 07 028	616 07 029	616 07 030	616 07 031
Code (200 kg)*	616 07 025 H	616 07 026 H	616 07 027 H	616 07 028 H	616 07 029 H	616 07 030 H	616 07 031 H
Height (mm) of the drawer	2 x 50  10 x 75  2 x 100  1 x 150 	10 x 75  3 x 100  1 x 150 	8 x 75  2 x 100  2 x 125  1 x 150 	6 x 75  3 x 100  3 x 150 	1 x 50  8 x 75  3 x 100  2 x 125 	4 x 50  6 x 75  4 x 100  1 x 150 	9 x 100  2 x 150 

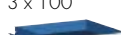
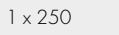
* Note! 50 mm high drawers always have a load capacity of 75 kg.

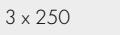
Drawer unit 70/140, 100% opening

Model	70/140-33	70/140-34	70/140-35	70/140-36	70/140-37	70/140-38	70/140-39	70/140-40
Code (75 kg)	616 07 033	616 07 034	616 07 035	616 07 036	616 07 037	616 07 038	616 07 039	616 07 040
Code (200 kg)*	616 07 033 H	616 07 034 H	616 07 035 H	616 07 036 H	616 07 037 H	616 07 038 H	616 07 039 H	616 07 040 H
Height (mm) of the drawer	1 x 50 	8 x 150 	8 x 75 	6 x 75 	2 x 75 	2 x 100 	12 x 75 	12 x 75 
	6 x 150 		6 x 100 	2 x 100 	2 x 150 	4 x 250 	2 x 150 	3 x 100 
	1 x 250 			2 x 150 	3 x 250 			
				1 x 250 				

* Note! 50 mm high drawers always have a load capacity of 75 kg.

Internal drawer dimensions: 612 x 612 x 35/60/85/110/135/235 mm.

Drawer interiors

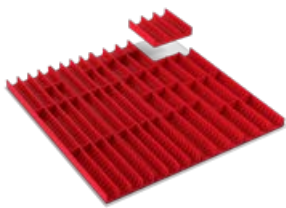

Tool troughs 33 and 45 mm

Drawer 70/50	837 911-00
Drawer 70/75	837 911-00



Divider Set 3

70/75	873 013-49
70/100	873 023-49
70/150 & 250	873 033-49
1 divider, 4 middle plates (4x300)	

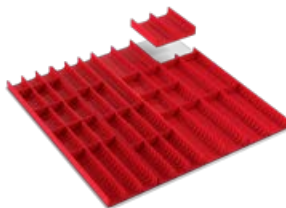

Tool troughs 45 and 70 mm

Drawer 70/50	837 938-00
Drawer 70/75	837 938-00

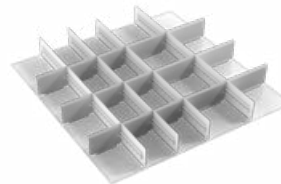

Divider Set 4

70/75	873 014-49
70/100	873 024-49
70/150 & 250	873 034-49
4 dividers, 15 middle plates (9x100, 6x150)	



Pick up boxes

Drawer 70/75	851 867-00
--------------	------------



Divider Set 5

70/75	873 015-49
70/100	873 025-49
70/150&250	873 035-49
2 dividers, 8 middle plates (6x150, 2x300)	



Divider Set 1

70/75	873 011-49
70/100	873 021-49
70/150 & 250	873 031-49
5 dividers, 18 middle plates (18x100)	



Divider Set 6

70/75	873 016-49
70/100	873 026-49
70/150&250	873 036-49
3 dividers, 11 middle plates (9x100, 2x300)	



Divider Set 2

70/75	873 012-49
70/100	873 022-49
70/150 & 250	873 032-49
3 dividers, 12 middle plates (12x150)	



Rubber mat for the drawer bottom

Rubber mat 70	852 718-00
---------------	------------

* One example of interior solutions shown in picture.



Cone racks for shelves and uprights

Cone racks HSK, Capto, ISO

Name	Size W x D mm	Max load kg	Code
Cone rack with base	562 x 145 x 105	50	854 435-49
Foot extension pair for cone rack with base			854 420-49
Cone rack with hooks	742 x 188 x 90	50	854 430-49

Tool brackets

Name	Rack with base can hold pcs	Rack with hooks can hold pcs	Code
ISO 50	6	8	837 770-00
HSK 40A/50B	7	9	854 215-00
HSK 63A/80B	5	7	854 217-00
HSK 100A/125B	5	7	854 219-00
Capto C4	7	9	854 201-00
Capto C5	7	9	854 202-00
Capto C6	4	6	854 203-00

Inserts for ISO 50 bracket

Name	Ø mm	Code
ISO 45 insert	45	837 730-00
ISO 40 insert	40	837 710-00
ISO 30 insert	30	837 690-00
Cylinder insert	50	852 311-00
Cylinder insert	40	852 310-00
Cylinder insert	30	852 309-00

The cone rack with base can be placed on a shelf or work surface. Additional extension parts available for more space under rack. The distance between each bracket is adjustable. The rack is equipped with handles.

The cone rack with hooks can be attached to M750 upright tubes. It can also be used in our industrial cabinets. Both cone racks are suitable for ISO, HSK and Capto tool brackets.



Cone rack with base



Cone rack with hooks











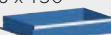

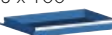

Drawer unit 90

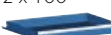
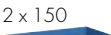
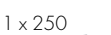

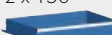



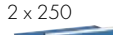

Drawers open 100% and their load capacity is 75 kg / 200 kg.

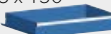

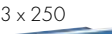
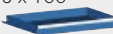

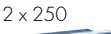

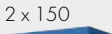









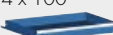

Easy to move with pallet truck or fork lift.

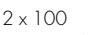
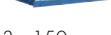
Drawer unit 90/110, 100% opening

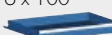

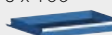









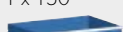

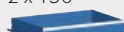

Model	90/110-1	90/110-2	90/110-3	90/110-4	90/110-13	90/110-20	90/110-21	90/110-33
Code (75 kg)	614 07 001	614 07 002	614 07 003	614 07 004	614 07 013	614 07 020	614 07 021	614 07 033
Code (200 kg)	614 07 001 H	614 07 002 H	614 07 003 H	614 07 004 H	614 07 013 H	614 07 020 H	614 07 021 H	614 07 033 H
Height (mm) of the drawer	2 x 100  3 x 150  1 x 250 	2 x 75  3 x 100  3 x 150 	9 x 100 	2 x 75  2 x 100  2 x 150  1 x 250 	6 x 100  2 x 150 	8 x 75  3 x 100 	1 x 150  3 x 250 	1 x 100  2 x 150  2 x 250 

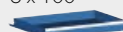

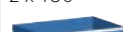

Model	90/110-34	90/110-43	90/110-44	90/110-45	90/110-46
Code (75 kg)	614 07 034	614 07 043	614 07 044	614 07 045	614 07 046
Code (200 kg)	614 07 034 H	614 07 043 H	614 07 044 H	614 07 045 H	614 07 046 H
Height (mm) of the drawer	6 x 150 	2 x 75  3 x 250 	3 x 100  4 x 150 	4 x 100  2 x 250 	8 x 75  2 x 150 

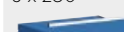
Drawer unit 90/140, 100% opening

Model	90/140-1	90/140-2	90/140-3	90/140-4	90/140-14	90/140-19	90/140-23	90/140-24
Code (75 kg)	617 07 001	617 07 002	617 07 003	617 07 004	617 07 014	617 07 019	617 07 023	617 07 024
Code (200 kg)	617 07 001 H	617 07 002 H	617 07 003 H	617 07 004 H	617 07 014 H	617 07 019 H	617 07 023 H	617 07 024 H
Height (mm) of the drawer	2 x 75  5 x 100  2 x 150  1 x 250 	2 x 75  6 x 100  3 x 150 	4 x 100  2 x 150  2 x 250 	4 x 75  2 x 100  3 x 150  1 x 250 	6 x 100  4 x 150 	16 x 75 	8 x 100  1 x 150  1 x 250 	12 x 100 

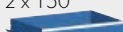
Drawer unit 90/140, 100% opening

Model	90/140-26	90/140-28	90/140-31	90/140-34	90/140-35	90/140-36	90/140-37	90/140-38
Code (75 kg)	617 07 026	617 07 028	617 07 031	617 07 034	617 07 035	617 07 036	617 07 037	617 07 038
Code (200 kg)	617 07 026 H	617 07 028 H	617 07 031 H	617 07 034 H	617 07 035 H	617 07 036 H	617 07 037 H	617 07 038 H
Height (mm) of the drawer	10 x 75  3 x 100  1 x 150 	6 x 75  3 x 100  3 x 150 	9 x 100  2 x 150 	8 x 150 	8 x 75  6 x 100 	6 x 75  2 x 100  2 x 150  1 x 250 	2 x 75  2 x 150  3 x 250 	2 x 100  4 x 250 

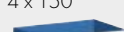
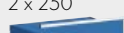
Model	90/140-39	90/140-40	90/140-42
Code (75 kg)	617 07 039	617 07 040	617 07 042
Code (200 kg)	617 07 039 H	617 07 040 H	617 07 042 H
Height (mm) of the drawer	12 x 75  2 x 150 	12 x 75  3 x 100 	1 x 100  4 x 150  2 x 250 

Internal drawer dimensions: 810 x 612 x 49/74/124/224 mm.

The large drawer units 90 and 130 include levelling screws, which help to level the unit on uneven surfaces.



Drawer interiors

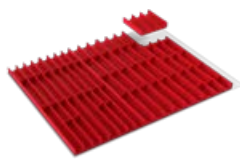

Tool troughs 33 and 45 mm

Drawer 90/75 837 913-00

Tool troughs leave 50 mm free space on one side of the drawer.



Tool troughs 45 and 70 mm

Drawer 90/75 837 914-00

Tool troughs leave 50 mm free space on one side of the drawer.



Pick up boxes

Drawer 90/75 851 870-00



Divider Set 1

90/75 873 041-49

90/100 873 051-49

90/150 & 250 873 061-49

7 dividers, 24 middle plates (24x100)



Divider Set 2

90/75 873 042-49

90/100 873 052-49

90/150 & 250 873 062-49

6 dividers, 21 middle plates (15x100, 6x150)



Divider Set 3

90/75 873 043-49

90/100 873 053-49

90/150 & 250 873 063-49

5 dividers, 17 middle plates (15x100, 2x300)



Divider Set 4

90/75 873 044-49

90/100 873 054-49

90/150 & 250 873 064-49

4 dividers, 14 middle plates (6x100, 6x150, 2x300)



Divider Set 5

90/75 873 045-49

90/100 873 055-49

90/150 & 250 873 065-49

3 dividers, 10 middle plates (6x100, 4x300)



Divider Set 6

90/75 873 046-49

90/100 873 056-49

90/150 & 250 873 066-49

5 dividers, 18 middle plates (6x100, 12x150)

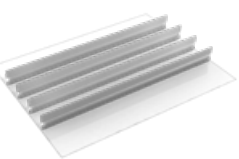

Divider Set 7

90/75 873 047-49

90/100 873 057-49

90/150 & 250 873 067-49

4 middle plates (4x800)



Rubber mat for the drawer bottom

Rubber mat 90 854 080-00











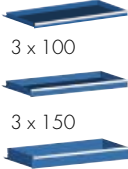
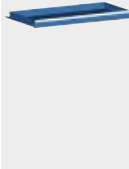





* One example of interior solutions shown in picture.

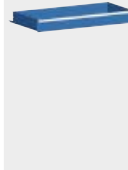





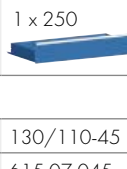

Drawer unit 130













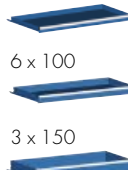









Easy to move with pallet truck or fork lift.

Drawer unit 130/110, 100% opening

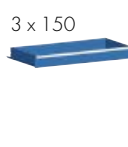

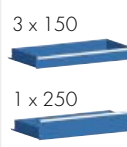















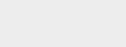





Model	130/110-1	130/110-2	130/110-3	130/110-4	130/110-13	130/110-20	130/110-21	130/110-33
Code (75 kg)	615 07 001	615 07 002	615 07 003	615 07 004	615 07 013	615 07 020	615 07 021	615 07 033
Code (200 kg)	615 07 001 H	615 07 002 H	615 07 003 H	615 07 004 H	615 07 013 H	615 07 020 H	615 07 021 H	615 07 033 H
Height (mm) of the drawer	2 x 100 	2 x 75 	9 x 100 	2 x 75 	6 x 100 	8 x 75 	1 x 150 	1 x 100 
	3 x 150 	3 x 100 		2 x 100 	2 x 150 	3 x 100 	3 x 250 	2 x 150 
	1 x 250 	3 x 150 		2 x 150 				2 x 250 
				1 x 250 				





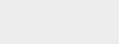

Model	130/110-34	130/110-43	130/110-44	130/110-45	130/110-46
Code (75 kg)	615 07 034	615 07 043	615 07 044	615 07 045	615 07 046
Code (200 kg)	615 07 034 H	615 07 043 H	615 07 044 H	615 07 045 H	615 07 046 H
Height (mm) of the drawer	6 x 150 	2 x 75 	3 x 100 	4 x 100 	8 x 75 
		3 x 250 	4 x 150 	2 x 250 	2 x 150 

Drawer unit 130/140, 100% opening

Model	130/140-1	130/140-2	130/140-3	130/140-4	130/140-14	130/140-19	130/140-23	130/140-24
Code (75 kg)	618 07 001	618 07 002	618 07 003	618 07 004	618 07 014	618 07 019	618 07 023	618 07 024
Code (200 kg)	618 07 001 H	618 07 002 H	618 07 003 H	618 07 004 H	618 07 014 H	618 07 019 H	618 07 023 H	618 07 024 H
Height (mm) of the drawer	2 x 75 	2 x 75 	4 x 100 	4 x 75 	6 x 100 	16 x 75 	8 x 100 	12 x 100 
	5 x 100 	6 x 100 	2 x 150 	2 x 100 	4 x 150 		1 x 150 	
	2 x 150 	3 x 150 	2 x 250 	3 x 150 			1 x 250 	
	1 x 250 			1 x 250 				

Drawer unit 130/140, 100% opening

Model	130/140-26	130/140-28	130/140-31	130/140-34	130/140-35	130/140-36	130/140-37	130/140-38
Code (75 kg)	618 07 026	618 07 028	618 07 031	618 07 034	618 07 035	618 07 036	618 07 037	618 07 038
Code (200 kg)	618 07 026 H	618 07 028 H	618 07 031 H	618 07 034 H	618 07 035 H	618 07 036 H	618 07 037 H	618 07 038 H
Height (mm) of the drawer	10 x 75  3 x 100  1 x 150 	6 x 75  3 x 100  3 x 150 	9 x 100  2 x 150  2 x 150 	8 x 150 	8 x 75  6 x 100  6 x 100 	6 x 75  2 x 100  2 x 150  1 x 250 	2 x 75  2 x 150  2 x 150  3 x 250 	2 x 100  4 x 250  4 x 250 

Model	130/140-39	130/140-40	130/140-42
Code (75 kg)	618 07 039	618 07 040	618 07 042
Code (200 kg)	618 07 039 H	618 07 040 H	618 07 042 H
Height (mm) of the drawer	12 x 75  2 x 150 	12 x 75  3 x 100 	1 x 100  4 x 150  2 x 250 

Internal drawer dimensions: 1226 x 612 x 49/74/124/224 mm.



Drawer interiors



Divider Set 1	
130/75	873 071-49
130/100	873 081-49
130/150 & 250	873 091-49
11 dividers, 36 middle plates (36x100)	



Divider Set 2	
130/75	873 072-49
130/100	873 082-49
130/150 & 250	873 092-49
9 dividers, 30 middle plates (18x100, 12x150)	

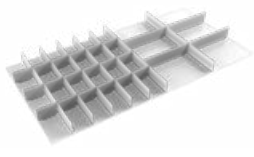

Divider Set 3	
130/75	873 073-49
130/100	873 083-49
130/150 & 250	873 093-49
7 dividers, 22 middle plates (18x100, 4x300)	

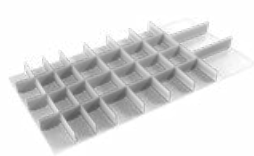

Divider Set 4	
130/75	873 074-49
130/100	873 084-49
130/150 & 250	873 094-49
7 dividers, 23 middle plates (9x100, 12x150, 2x300)	



Divider Set 5	
130/75	873 075-49
130/100	873 085-49
130/150 & 250	873 095-49
7 dividers, 16 middle plates (16x150)	



Rubber mat for the drawer bottom	
Rubber mat 130	854 082-00



Divider Set 6	
130/75	873 076-49
130/100	873 086-49
130/150 & 250	873 096-49
5 dividers, 16 middle plates (12x150, 4x300)	



Divider Set 7	
130/75	873 077-49
130/100	873 087-49
130/150 & 250	873 097-49
3 dividers, 12 middle plates (12x300)	

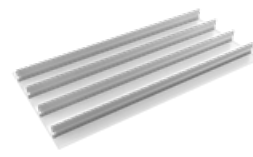

Divider Set 8	
130/75	873 078-49
130/100	873 088-49
130/150 & 250	873 098-49
4 middle plates (4x1200)	

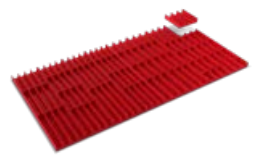

Tool troughs 33 and 45 mm	
Drawer 130/75	837 912-00



Tool troughs 45 and 70 mm	
Drawer 130/75	837 939-00



Pick up boxes	
Drawer 130/75	851 872-00

* One example of interior solutions shown in picture.



Industrial shelving and cabinets





Industrial shelving and cabinets

Shelves and cabinets help keep the workplace in good order. During selection the space available and load capacity required must be taken into account. Shelving units are also excellent as room dividers. ESD protection is also available.

Extended tool life

The service life and condition of tools can be significantly improved through their appropriate storage. They can be stored in their own places, protected from dust and dirt, in a locked cabinet.

A versatile storage solution is created by using suitable accessories

An open shelf is not always the best way to store things. Tools, expensive equipment, and small items need another type of solution. Through using lockable drawers or adding doors and panels, an open shelving system is

turned into a versatile storage solution. Drawers can be fitted with a variety of interior combinations, to suit the tools stored in them.

Storage system is modifiable

A storage system is built around the basic component: extension parts, doors, screens, and other accessories can be added to create an efficient overall solution. In addition the shelf heights can easily be adjusted as needed. Even the load capacity can be increased by adding additional supports.

Heavy storage system is designed for heavy items

When the items are heavy, shelves need to be very strong as well. Computer servers or large measurement instruments can be surprisingly heavy. A heavy storage system is designed for load capacities of up to 400 kg/shelf.

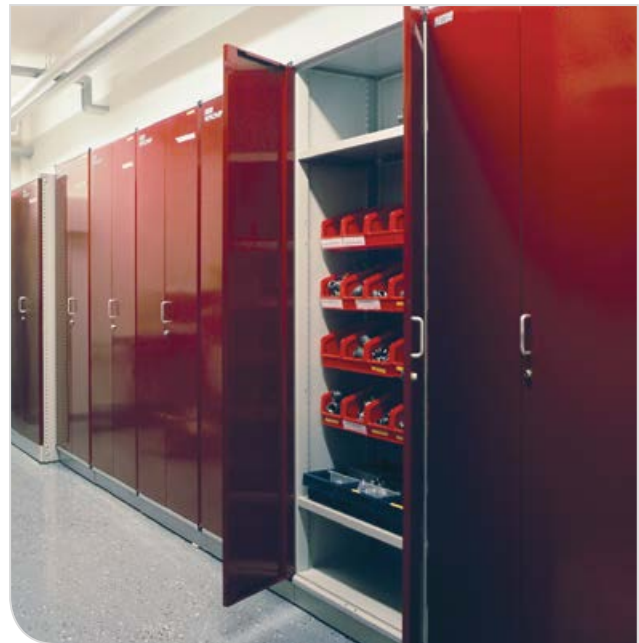

Industrial cabinets allow for a tidy, efficient working environment

No unnecessary time should be spent looking for tools and materials. This interrupts work and causes stress. In a well-equipped cabinet, everything is where it should be. A ready-assembled cabinet is easy to move to the most convenient location. There are adjustable glides under the cabinet. This makes it easy to adjust the cabinet so that it stands straight on uneven surfaces. All module-750 and -500 accessories, such as shelves, drawer units, perforated panels, and extendable shelves, can be used in selecting accessories for the cabinet.



Shelving system

Shelving system can be built as a combination of cabinets and shelves and you can use it as a space divider. The storage system is available in two standard heights: 200 cm and 240 cm and two widths: 80 cm and 100 cm.



All standard and extension parts include 6 shelves.

Standard bays

Name	Size W x D mm	Code
Standard bay 80/30/200	824 x 300 x 2000	C 313 49 001P
Standard bay 80/40/200	824 x 400 x 2000	C 314 49 001P
Standard bay 100/30/200	1024 x 300 x 2000	C 313 49 002P
Standard bay 100/40/200	1024 x 400 x 2000	C 314 49 003P
Standard bay 100/50/200	1024 x 500 x 2000	C 315 49 001P
Standard bay 100/60/200	1024 x 600 x 2000	C 316 49 001P
Standard bay 80/40/240	824 x 400 x 2400	C 314 49 002P
Standard bay 100/40/240	1024 x 400 x 2400	C 314 49 004P
Standard bay 100/50/240	1024 x 500 x 2400	C 315 49 002P
Standard bay 100/60/240	1024 x 600 x 2400	C 316 49 002P

Extension bays

Name	Size W x D mm	Code
Extension bay 80/30/200	804 x 300 x 2000	C 323 49 001P
Extension bay 80/40/200	804 x 400 x 2000	C 324 49 001P
Extension bay 100/30/200	1004 x 300 x 2000	C 323 49 002P
Extension bay 100/40/200	1004 x 400 x 2000	C 324 49 003P
Extension bay 100/50/200	1004 x 500 x 2000	C 325 49 001P
Extension bay 100/60/200	1004 x 600 x 2000	C 326 49 001P
Extension bay 80/40/240	804 x 400 x 2400	C 324 49 002P
Extension bay 100/40/240	1004 x 400 x 2400	C 324 49 004P
Extension bay 100/50/240	1004 x 500 x 2400	C 325 49 002P
Extension bay 100/60/240	1004 x 600 x 2400	C 326 49 002P

All standard and extension bays include 6 shelves



The W x D x H rule

All our dimensions follow a WDH rule, where the first dimension is the width (W), the middle the depth (D), and the last the height (H).

Combination name

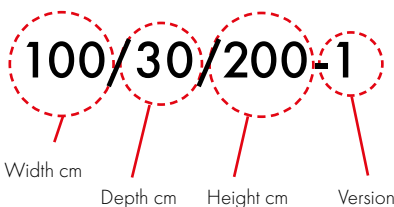

Load capacity

1000 kg/bay

width 824 mm

150 kg/shelf

width 1024 mm

150 kg/shelf

Shelving system combinations



100/30/200-8 C 340 07 108

Qty	Name	Size mm	Code
3	End frame/open	300 x 2000	830 615-49
8	Shelf+brackets	1000 x 300	852 175-49
4	Perforated panel	983 x 500	852 145-07
2	Cross support pair 1000		852 176-49



1. 100/40/200-1 C 344 07 001

Qty	Name	Size mm	Code
1	Cabinet 100/40/200	1030 x 430 x 2010	C 344 07 000
4	Shelf	1000 x 400	852 231-49



Move with a pallet truck

The cabinet can be moved with a pallet truck or a forklift when the plinth front panel has been removed. Cabinets are equipped with adjustment screws.



2. 100/40/200-4 C 344 07 004

Qty	Name	Size mm	Code
1	Cabinet 100/40/200	1030 x 430 x 2010	C 344 07 000
2	Shelf	1000 x 400	852 231-49
2	Perforated panel	983 x 500	852 145-07
3	Drawer 400		834 513-49



100/40/200-9 C 340 07 109

Qty	Name	Size mm	Code
2	End frame/open	400 x 2000	830 895-49
14	Shelf+brackets	1000 x 400	852 231-49
2	Cross support pair 1000		852 176-49
2	Perforated panel	983 x 500	852 145-07
1	Cabinet 100/40/200	1030 x 430 x 2010	C 344 07 000

Shelving system includes a wide range of different parts which can be used to create a fully tailor-made solution.

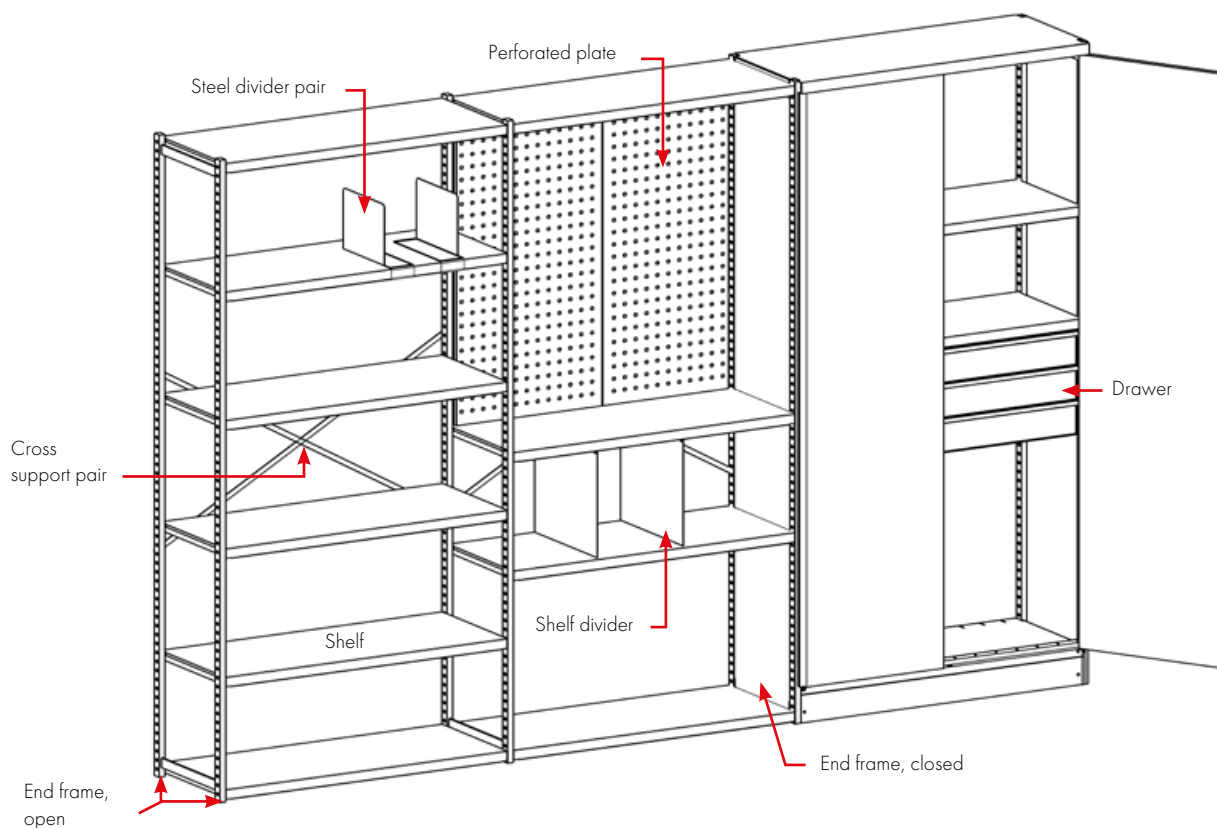

Shelving system components

Name	Size D x H mm	Code
End frame, open	300 x 2000	830 615-49
End frame, open	400 x 2000	830 895-49
Sidewall	400 x 2000	859 440-49
End frame, open	500 x 2000	851 719-49
Sidewall	500 x 2000	859 450-49
End frame, open	600 x 2000	851 725-49
Sidewall	600 x 2000	859 460-49
End frame, open	400 x 2400	851 717-49
End frame, open	500 x 2400	851 721-49
End frame, open	600 x 2400	851 724-49
Cross support pair 1000		852 176-49
Cabinet 100/40/200	1030 x 430 x 2010	C 344 07 000
Cabinet 100/50/200	1030 x 530 x 2010	C 345 07 000
Cabinet 100/60/200	1030 x 630 x 2010	C 346 07 000
Back wall 1000	1000 x 2000	859 447-49
Perforated end plate 400	340 x 2000	830 917-07
Screw set (fixing back to back)		838 440-51
Perforated panel 1000	983 x 500	852 145-07
Additional support for shelf 1000		852 267-49

Shelves

Name	Size W x D mm	Max load kg	Code
Shelf	800 x 300	150	852 235-49
Shelf	800 x 400	150	852 234-49
Shelf	1000 x 300	150	852 175-49
Shelf	1000 x 400	150	852 231-49
Shelf	1000 x 500	150	852 185-49
Shelf	1000 x 600	150	852 187-49

Shelf dividers

Name	Size D x H mm	Code
Steel divider pair	190 x 285	861 116-49
Divider pair	190 x 385	861 118-49
Shelf divider 400	400 x 180	832 839-49
Shelf divider 400	400 x 260	832 847-49
Shelf divider 400	400 x 370	832 855-49
Shelf divider 500	500 x 260	852 271-49
Shelf divider 500	500 x 370	852 273-49
Shelf divider 600	600 x 260	852 797-49
Shelf divider 600	600 x 370	852 798-49

Drawers and interior combinations

Name	Size W x D x H mm	Max load kg	Code
Drawer 100/100, for 400 deep cabinet	920 x 345 x 107	30	834 513-49
Drawer 100/100, for 500 deep cabinet	920 x 345 x 107	30	834 514-49
1 Middle divider and middle plates			834 507-49
2 Middle divider and middle plates			834 508-49
3 Middle divider and middle plates			834 509-49
4 Pick up boxes			834 512-00

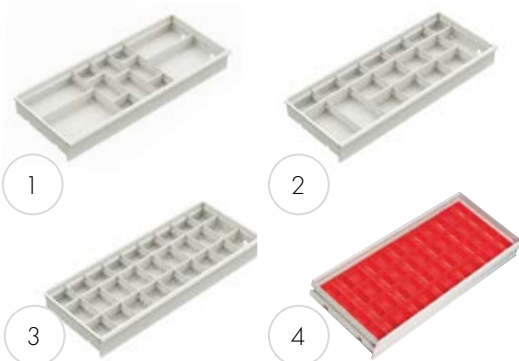

Heavy shelving system

Heavy shelving system is suitable for large and heavy items. The shelf load capacity is 400 kg and the shelf depth is 70 cm. It can be built as a combination of cabinets, drawers and shelves. The heavy storage system comes in one standard height of 200 cm and two widths: 75 cm and 95 cm.



All standard and extension bays include 6 shelves.



Standard bays

Name	Size W x D x H mm	Code
Standard bay, open	750 x 714 x 2000	C 375 49 001
Standard bay, closed*	750 x 714 x 2000	C 376 49 001
Standard bay, open	950 x 714 x 2000	C 395 49 001
Standard bay, closed*	950 x 714 x 2000	C 396 49 001

*The standard bay, closed, includes back sheet and closed ends.

Extension bays

Name	Size W x D x H mm	Code
Extension bay, open	705 x 714 x 2000	C 377 49 001
Extension bay, closed*	705 x 714 x 2000	C 378 49 001
Extension bay, open	905 x 714 x 2000	C 397 49 001
Extension bay, closed*	905 x 714 x 2000	C 398 49 001

*The standard bay, closed, includes back sheet and closed ends.



The W x D x H rule

All our dimensions follow a WDH rule, where the first dimension is the width (W), the middle the depth (D), and the last the height (H).

Load capacity

2000 kg/bay

width 750 mm



400 kg/shelf

width 950 mm



350 kg/shelf

Heavy shelving system combinations



95/200-1 C 395 49 001

Qty	Name	Size mm	Code
2	End frame/open	714 x 2000	852 002-49
6	Shelf 90	860 x 714	852 012-49
1	Cross support pair		851 671-49



75/200-2 C 377 07 002

Qty	Name	Size mm	Code
2	Base/top 70	660 x 714	852 004-49
1	Back sheet 70	740 x 1990	852 009-49
2	End frame/closed	714 x 2000	852 449-49
5	Shelf 70	660 x 714	852 003-49
1	Door pair	700 x 2000	852 000-07

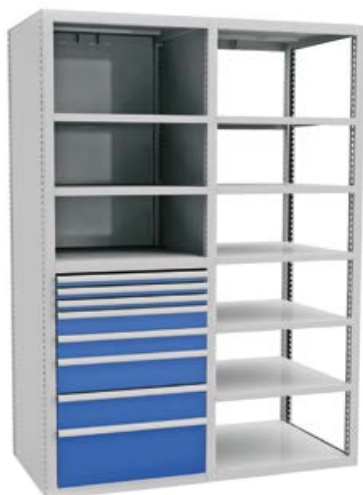

75/200-28 C 399 07 008

Qty	Name	Size mm	Code
1	Locking shelf	660 x 714	852 007-49
1	End frame/open	714 x 2000	852 002-49
4	Base/top 70	660 x 714	852 004-49
7	Shelf 70	660 x 714	852 003-49
1	Locking element		851 675-49
2	End frame/closed	714 x 2000	852 449-49
3	Drawer 70/50	612 x 612 x 50	833 967-07
2	Drawer 70/100	612 x 612 x 100	833 975-07
2	Drawer 70/150	612 x 612 x 150	833 983-07
1	Drawer 70/250	612 x 612 x 250	833 991-07
1	Back sheet 70	740 x 1990	852 009-49



75/200-9 C 399 07 009

Qty	Name	Size mm	Code
1	Locking shelf	660 x 714	852 007-49
4	Base/top 70	660 x 714	852 004-49
7	Shelf 70	660 x 714	852 003-49
3	End frame/closed	714 x 2000	852 449-49
3	Drawer 70/50	612 x 612 x 50	833 967-07
2	Drawer 70/100	612 x 612 x 100	833 975-07
2	Drawer 70/150	612 x 612 x 150	833 983-07
1	Drawer 70/250	612 x 612 x 250	833 991-07
2	Back sheet 70	740 x 1990	852 009-49
1	Door pair	700 x 2000	852 000-07
1	Locking element		851 675-49

Combination name

95/200+1

Width cm

Height cm

Version

Heavy shelving system includes a wide range of different parts which can be used to create a fully tailor-made solution.

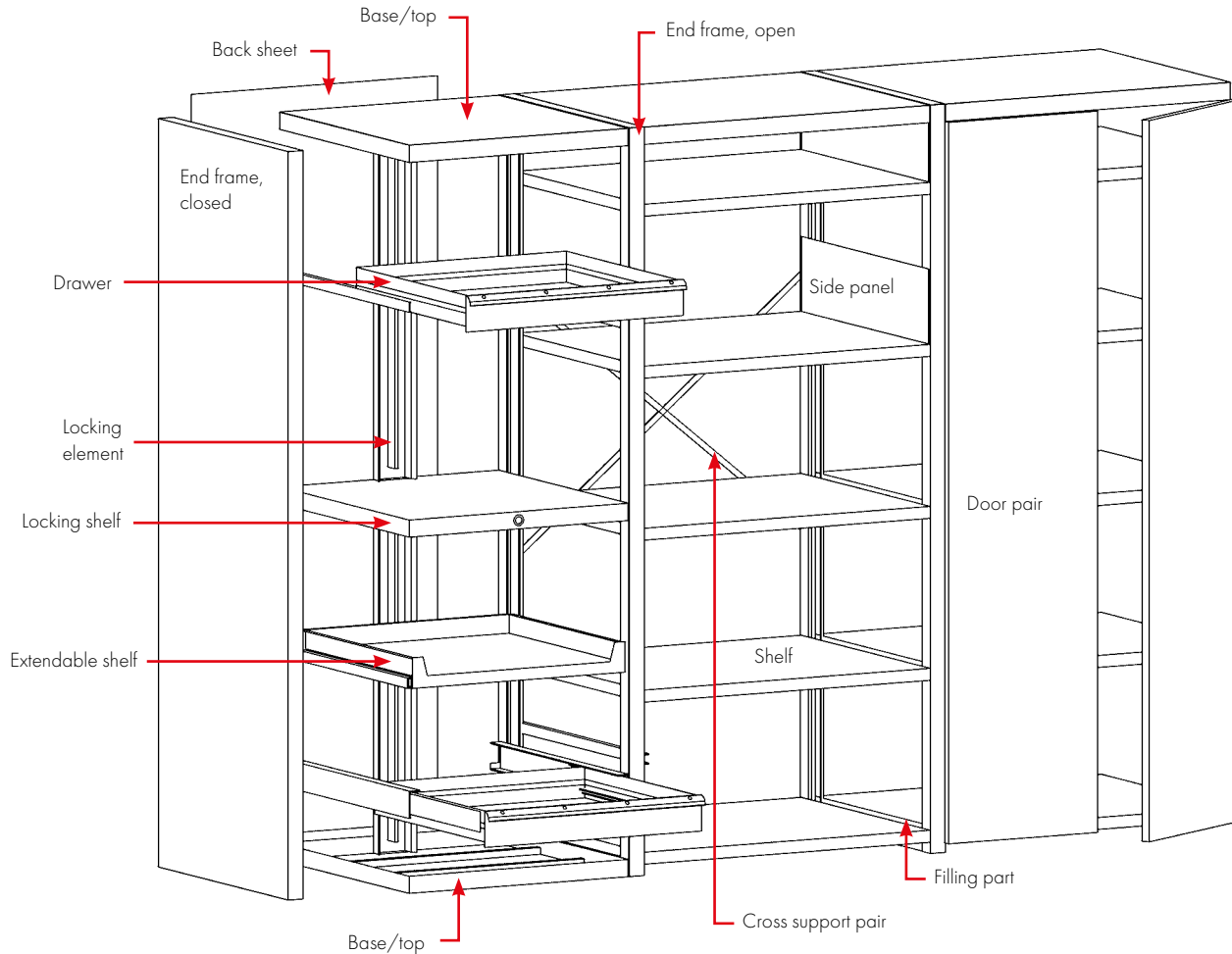

Heavy shelving system components

Name	Size W x D mm	Max load kg	Code
End frame/open	714 x 2000		852 002-49
End frame/closed	714 x 2000		852 001-49
Base/top 70	660 x 714		852 004-49
Base/top 90	860 x 714		852 013-49
Cross support pair			851 671-49
Back sheet 70	740 x 1990		852 009-49
Back sheet 90	940 x 1990		852 016-49
Shelf 70	660 x 714	400	852 003-49
Shelf 90	860 x 714	350	852 012-49
Door pair*	700 x 2000		852 000-07
Door pair*	900 x 2000		852 011-07
Locking shelf 70*	660 x 714		852 007-49
Locking shelf 90*	860 x 714		852 015-49
Locking element	1000		851 675-49

*Door/locking shelf equipped with lock

Heavy shelving system drawers

Name	Size W x D mm	Effective height mm	Max load kg	Opens %	Code
Drawer 70/50	612 x 612 x 50	35	75	100	833 967-07
Drawer 70/75	612 x 612 x 75	60	75	100	833 401-07
Drawer 70/100	612 x 612 x 100	85	75	100	833 975-07
Drawer 70/125	612 x 612 x 125	110	75	100	833 320-07
Drawer 70/150	612 x 612 x 150	135	75	100	833 983-07
Drawer 70/250	612 x 612 x 250	235	75	100	833 991-07
Extendable shelf 70	612 x 612 x 85		75	100	852 017-07
Extendable shelf 90	860 x 612 x 85		75	100	852 019-07
Drawer 90/75	860 x 612 x 75	49	75	100	854 262-07
Drawer 90/100	860 x 612 x 100	74	75	100	854 246-07
Drawer 90/150	860 x 612 x 150	124	75	100	854 248-07
Drawer 90/250	860 x 612 x 250	224	75	100	854 249-07



For 200 kg loading capacity on drawers and extendable shelves add H to the end of code (not available for drawer 70/50).

Shelving cabinets

Shelving cabinets are made of epoxy powder coated steel. The frames are painted with light grey RAL 7035 and doors either with blue RAL5007 or with light grey RAL7035. The cabinet has sturdy double leaf-doors, flush fitting handle with two keys. Shelving cabinet can be moved with fork lift. There are leveling screws under the cabinet for adjusting the cabinet straight. The shelving cabinets are pre-assembled.

Loading capacity 150kg/shelf, 600kg/cabinet.



Move with a pallet truck

The cabinet can be moved with a pallet truck or a forklift when it is empty. Cabinets are equipped with adjustment screws.



Name	Size W x D x H mm	Code
Shelving cabinet 100/40/200	1030 x 430 x 2010	SC10040200-07
Shelving cabinet 100/50/200	1030 x 530 x 2010	SC10050200-07
Shelving cabinet 100/60/200	1030 x 630 x 2010	SC10060200-07

Includes 4 shelves. For additional shelves see page 80.



The W x D x H rule

All our dimensions follow a WDH rule, where the first dimension is the width (W), the middle the depth (D), and the last the height (H).

Combination name

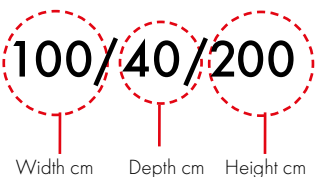

Load capacity

150 kg/shelf

600 kg/cabinet





Storage and charging cabinet

A storage and charging cabinet is ideal for storing personal valuables during the workday and at the same time it provides a possibility to charge mobile phones/tablets/laptops. The storage and charging cabinet consists of six lockers and each locker is equipped with a double socket and a secure electronic code lock. This electronic locking system replaces keys with a numerical code.

The locking system is operated with 2 x AAA batteries and is thus independent of an external power supply. Due to an automatic low power (sleep) mode, the batteries are long lasting, and even when the battery power is low, the lock can still be opened up to 300 times.

Storage and charging cabinets are made of epoxy powder-coated steel. The frames are painted with light grey RAL 7035 and doors either with light grey RAL 7035 or with red RAL 3002. On the back panel of the lockers there is perforation for air ventilation. The inner measurements of the lockers are D x W x H 430 x 310 x 205 mm. Storage and charging cabinets are pre-assembled.

Name	Size W x D x H mm	Internal locker dimensions mm	Code
Storage and charging cabinet, grey doors	350 x 540 x 1525	310 x 430 x 205	SCC-41
Storage and charging cabinet, red doors	350 x 540 x 1525	310 x 430 x 205	SCC-25



Industrial cabinets

Treston industrial cabinets include a wide range of accessories e.g. for tool storage, allowing a versatile storage solution to be created.



All cabinets are also available with flush fitting handle lock or digital code lock.

Alternate locking method can be ordered by adding a T or E in the end of the product code (e.g. C309 07 000 T).



T = for flush fitting handle.



E = for digital code lock

Both locks are also available to the industrial shelving system and heavy shelving system cabinets.

Industrial cabinet combinations



55/100-1 C 301 07 001

Qty	Name	Code
1	Cabinet frame 55/100	C 301 07 000
2	Steel shelf 55	854 349-49

(Flush fitting handle not suitable)



80/100-1 C 305 07 001

Qty	Name	Code
1	Cabinet frame 80/100	C 305 07 000
2	Steel shelf 80	854 345-49



80/100-2 C 305 07 002

Qty	Name	Code
1	Cabinet frame 80/100	C 305 07 000
2	Steel shelf 80	854 345-49
1	Drawer 80	854 346-49

Combination name

55/100-1

Width cm

Height cm

Version

Depth of cabinet: 425 mm



Practical!

100 cm high cabinet tops have a back stop and rubber mat to be used as an additional work top.



Computer cabinet

Computer cabinet protects equipment from dust and dirt, even in the most demanding conditions. The computer cabinet is pressurised and equipped with an air filter that keeps the dust out. A screen up to a maximum size of 26" will fit in the computer cabinet.



Computer cabinets

Name	Size mm	Code
Computer cabinet	800 x 500 x 1600	854 358-49
Computer cabinet (without the energy rail)	800 x 500 x 1600	854 364-49

(Flush fitting handle not suitable)



55/160-1 C 303 07 001

Qty	Name	Code
1	Cabinet frame 55/160	C 303 07 000
3	Steel shelf 55	854 349-49

(Flush fitting handle not suitable)

80/160-1 C 307 07 001

Qty	Name	Code
1	Cabinet frame 80/160	C 307 07 000
3	Steel shelf 80	854 345-49

80/160-2 C 307 07 102

Qty	Name	Code
1	Cabinet frame 80/160	C 307 07 000
2	Steel shelf 80	854 345-49
4	Suspension rail, M750	859 151-49
21	Plastic container 1015-5	806 207-00
5	Container, 1525-5	806 208-00

80/160-3 C 307 07 003

Qty	Name	Code
1	Cabinet frame 80/160	C 307 07 004
3	Steel shelf 80	854 345-49
1	Extendable shelf 80	854 347-49

(Flush fitting handle not suitable)



More space for tools

A much larger amount of space is available for storing tools if the perforated wall panel 854 353-07 is installed on the door or side wall of cabinet 80.

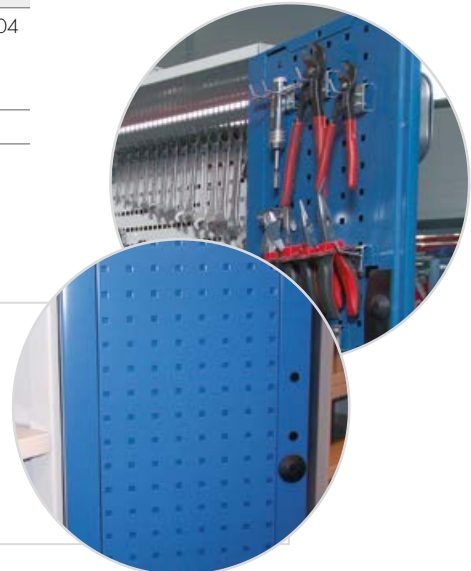



Move with a pallet truck

The cabinet can be moved with a pallet truck or a forklift when the plinth front panel has been removed. Cabinets are equipped with adjustment screws.



80/200-1 C 309 07 001

Qty	Name	Code
1	Cabinet frame 80/200	C 309 07 000
4	Steel shelf 80	854 345-49



80/200-2 C 309 07 102

Qty	Name	Code
1	Cabinet frame 80/200	C 309 07 000
2	Drawer 80	854 346-49
2	Steel shelf 80	854 345-49
5	Plastic container 1525-5	806 208-00
1	Suspension rail, M750	859 151-49
1	Extendable shelf 80	854 347-49
1	Perforated panel 718 x 612	861 512-07
2	Perforated panel 288 x 712	854 353-07
1	Pair of support feet	864 730-49



80/200-3 C 309 07 103

Qty	Name	Code
1	Cabinet frame 80/200	C 309 07 000
2	Drawer 80	854 346-49
2	Steel shelf 80	854 345-49
3	Shelf divider H 370/400	832 855-49
1	Perforated panel 736x 640	835 633-07
1	Extendable shelf 80	854 347-49
1	Pair of support feet	864 730-49
1	Pair of steel dividers	861 116-49
1	Drawer for suspension folders	854 348-49



An extendable shelf for the cabinet

When the cabinet is used for storing folders, a separate extending shelf is a good idea. This shelf makes it easy to browse through the folders.



Industrial cabinet accessories

All the M750 accessories fit the cabinet 80 and can be easily installed inside.

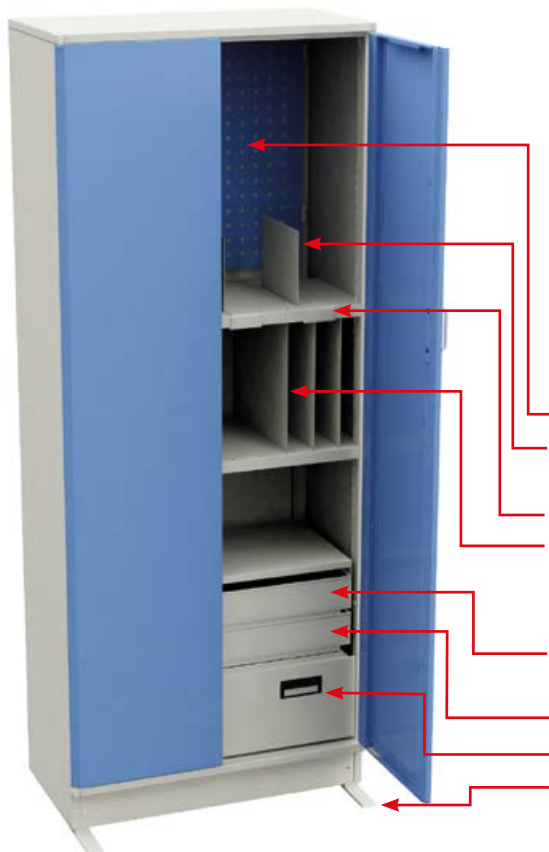

Cabinet frames

Name	Size W x D x H mm	Code
Cabinet frame 55/100	550 x 425 x 1000	C 301 07 000
Cabinet frame 80/100	800 x 425 x 1000	C 305 07 000
Cabinet frame 55/160	550 x 425 x 1600	C 303 07 000
Cabinet frame 80/160	800 x 425 x 1600	C 307 07 000
Cabinet frame 80/160, half doors	800 x 425 x 1600	C 307 07 004
Cabinet frame 80/200	800 x 425 x 2000	C 309 07 000

Cabinet frames can be ordered with a turning handle with integrated key lock by adding a T in the end of the product code (e.g. C309 07 000 T).

Cabinet accessories

Name	Size W x D x H mm	Max load kg	Code
Perforated panel for the door or side wall	290 x 740		854 353-07
Perforated panel for the back wall M500	468 x 389		860 951-49
Perforated panel for the back wall M750	736 x 640		835 633-07/-49
Perforated panel for the back wall M750	736 x 1003		835 641-07/-49
Pair of steel dividers	1 x 285 x 190		861 116-49
Steel shelf 55	545 x 391 x 32	100	854 349-49
Steel shelf 80	730 x 396 x 32	100	854 345-49
Shelf divider	1 x 400 x 180		832 839-49
Shelf divider	1 x 400 x 260		832 847-49
Shelf divider	1 x 400 x 370		832 855-49
Extendable shelf 80	730 x 362 x 42	30	854 347-49
Drawer 55	480 x 362 x 90	30	854 344-49
Drawer 80	730 x 362 x 90	30	854 346-49
Drawer for suspension folders	724 x 350 x 240	30	854 348-49
Pair of support feet	40 x 220 x 6		864 730-49
Suspension rail		50	859 151-49

Cone rack with hooks HSK, Capto, ISO

Name	Size W x D x H mm	Max load kg	Code
Cone rack with hooks	742 x 188 x 90	50	854 430-49

Tool brackets

Name	Rack with hooks can hold pcs	Code
ISO 50	8	837 770-00
HSK 40A/50B	9	854 215-00
HSK 63A/80B	7	854 217-00
HSK 100A/125B	7	854 219-00
Capto C4	9	854 201-00
Capto C5	9	854 202-00
Capto C6	6	854 203-00



Cone rack with hooks

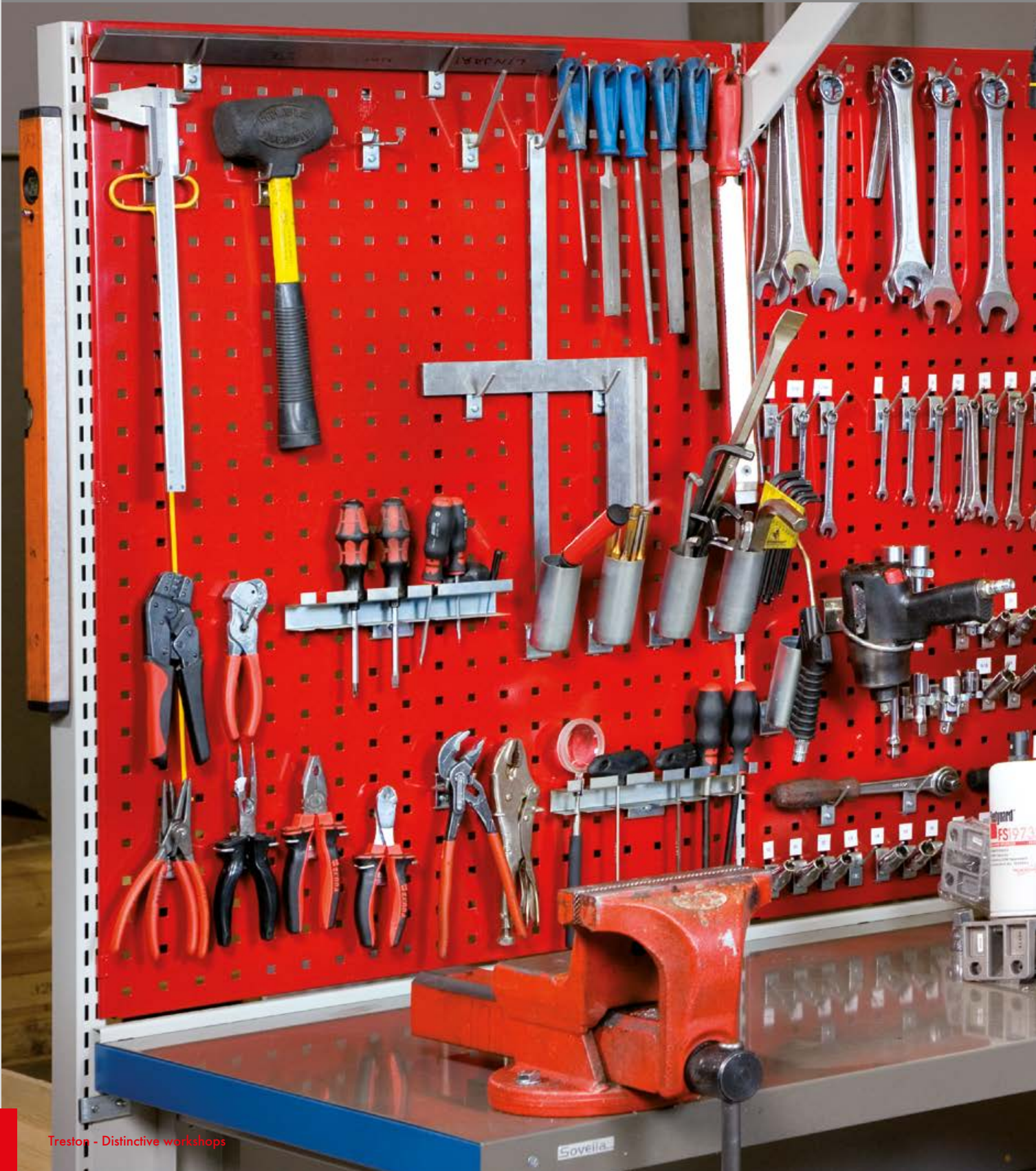

Perforated panels and tool storage systems



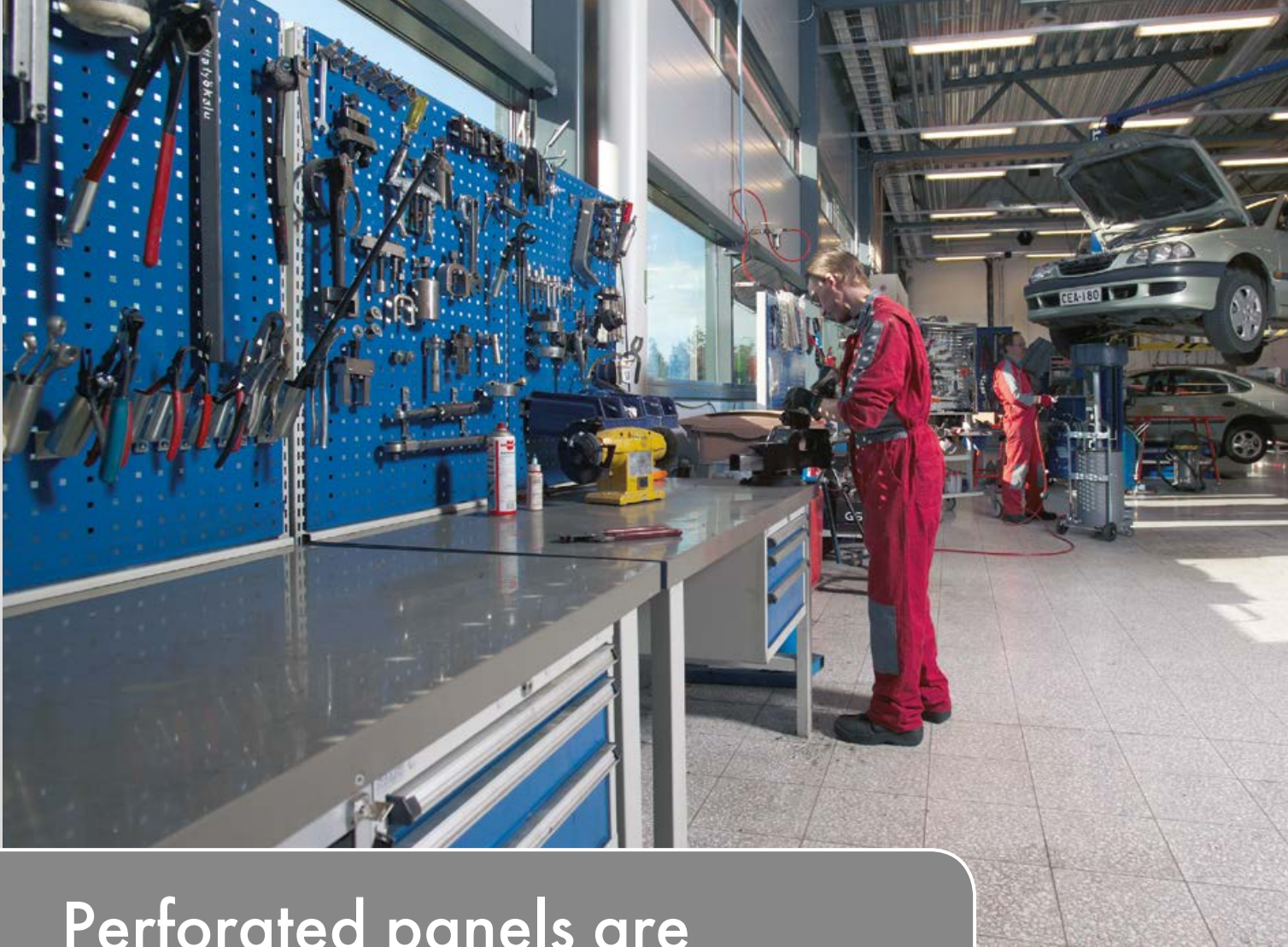

Perforated panels are a part of good organisation

Perforated panels are efficient dividers of space and, at the same time, practical storage facilities for tools and equipment. An industrial screen can be used as a sound-insulating space divider by equipping it with back panel elements with fireproof insulation.

Order and tidiness are appreciated

Order and tidiness cannot be achieved and maintained without there being a place for each tool. Perforated panels and hooks offer a practical and versatile solution for storing tools and equipment. Perforated panel products are available for direct fastening to the wall or for fastening to upright profiles or tubes.

Hooks also for heavy loads

The hooks can withstand loads of up to 10 kg.





In addition to the perforated panels, you can attach metal shelves, bin rails, perforated cabinets and light/balancer rails to the upright profiles.



Perforated back and wall panels

The perforated back panels are fastened to the upright tubes or straight to TPH bench with panel hooks. The perforated wall panels are attached, either directly to the wall with screws or to the upright profiles with fastening clips. The size of the perforation is 9 x 9 mm, centre to centre 38 mm.

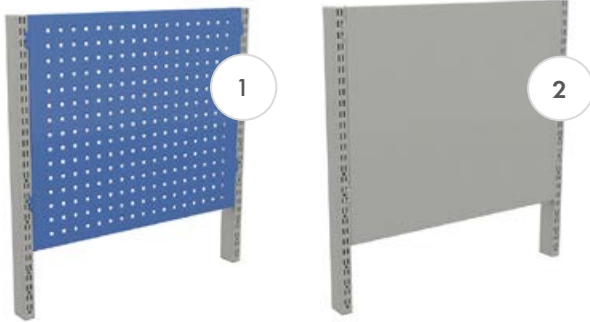

The colour code is included in those product codes that are formed with numbers.

It is either at the end, following the hyphen (e.g. 860 804-49), or in the middle (e.g. C 334-07-000).

1. Perforated panels for upright tubes

Name	Module	Size W x H mm	Code
Perforated back panel	M500	468 x 389	861 501-49
Perforated back panel	M750	718 x 194	861 510-07
Perforated back panel	M750	718 x 389	861 511-49
Perforated back panel	M750	718 x 612	861 512-07/-49
Perforated back panel, insulated	M750	718 x 612	861 701-07/-49
Perforated back panel	M750	718 x 1003	861 514-07/-49
Perforated back panel	M900	871 x 389	861 516-49
Perforated back panel	M900	871 x 612	861 517-07/49
Perforated back panel	M900	871 x 1003	861 519-07/49
Perforated back panel	M1000	968 x 389	861 532-49
Perforated back panel	M1000	968 x 612	861 538-07/49
Perforated back panel	M1000	968 x 1003	861 535-07
Perforated back panel	M1200	1168 x 389	861 533-49
Perforated back panel	M1350	1318 x 389	861 521-49
Perforated back panel	M1500	1474 x 389	861 526-49
Perforated back panel	M1800	1774 x 389	861 531-49

Fastened to the upright tubes (see page 24).

2. Back panels for upright tubes

Name	Module	Size W x H mm	Code
Back panel	M500	468 x 389	861 541-49
Back panel	M750	718 x 194	861 550-49
Back panel	M750	718 x 389	861 551-49
Back panel	M750	718 x 612	861 552-49
Back panel	M900	871 x 389	861 556-49

Fastened to the upright tubes (see page 24).

3. Perforated panels for TPH benches

Size W x H mm	Suitable for	Code
1115 x 750	TPH712	RL120
1415 x 750	TPH715/ 915	RL150
1715 x 750	TPH718/ 918	RL180
Panel hooks	TPH	RK1

Mount on TPH benches with panel hooks RK1. Can also be attached to a wall with screws (included).

4. Perforated wall panels fastened to the wall

Name	Size W x H mm	Code
Perforated wall panel	454 x 988	837 369-07
Perforated wall panel	949 x 988	837 334-07
Perforated wall panel	949 x 1444	837 342-07
Perforated wall panel	949 x 1976	837 350-07

Fastened directly to the wall using screws.



Industrial screens

Industrial screens are modular, and they can be equipped with all M750 accessories illustrated from page 26 onward. Industrial screens can be used as space dividers. They also provide noise insulation; the combinations available have perforated back panels on both sides and one side is insulated.

Industrial screens

Name	Size W x H mm	Code
Standard panel, T-feet	780 x 60 x 1850	C 520 07 101
Extension panel, T-foot	750 x 560 x 1850	C 520 07 102
Extension panel, L-foot	750 x 310 x 1850	C 520 07 103
Extension panel, I-foot	750 x 60 x 1850	C 520 07 104

Includes 6 perforated back panels, 3 pcs/side.
The standard panel includes two feet, the extension panel includes one foot.

Parts

Name	Size W x H mm	Code
T-foot	1850	836 516-49
L-foot	1850	836 532-49
I-foot	1850	836 597-49
Spacer bar	750	835 838-49
Corner joint pair		847 615-51
Perforated back panel M750	718 x 17 x 612	861 512-07/-49
Perforated back panel M750, insulated*	718 x 17 x 612	861 701-07/-49
Upper list	718 x 65	851 907-07

The wall module requires two spacer bars.

* The insulation material used is polyether foam.

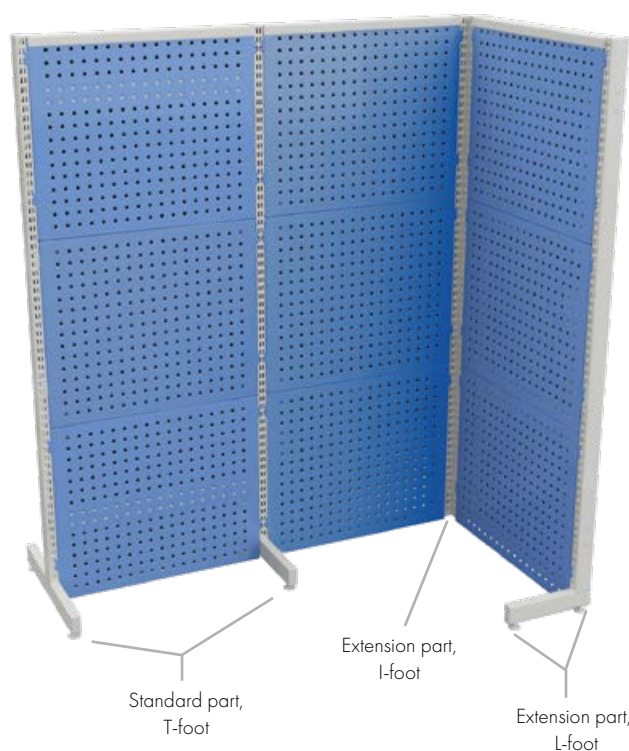

Tool storage system



Tool storage system requires only 2 m² of floor space and provides 16 m² of storage space. There is no need to fasten it to the floor, as it stands firmly on its own. There is a castor on the lower edge of the panels which makes them easy to move.

The load capacity is 100 kg/panel. Includes 4 panels; additional panels are available (ordered separately). A maximum of 10 panels can be fastened to the tool storage system.

Tool storage system

Name	Size W x H mm	Code
Tool storage system, 4 panels	1025 x 1035 x 2125	830 518-07P
Additional panel	15 x 949 x 1976	830 682-07P



Cabinet style tool storage



WATCH THIS ANIMATION showcasing the versatile usage options of our technical furniture: Tool storage system | <https://vimeo.com/213996808>

Treston Tower storage and workstation unit

Being versatile and easily customisable for different environments and tasks, the Treston Tower storage and workstation unit is ideal for, for example, vehicle and machinery assembly lines, service and maintenance departments, and for any work that requires plenty of mobile storage and workspace near the product under work.

When the storage and/or load capacity of a wheeled service trolley or drawer unit is not enough and you need a unit that is easier to move than a fixed workstation and can be equipped in many ways, the Treston Tower storage and workstation unit is the correct choice.

The frame is made of powder-coated steel (grey, RAL7045). Accessories and add-on products are available in light grey (RAL7035).



Treston Tower storage and workstation unit

Name	Size W x D x H mm	Max load kg	Code
Treston Tower frame	860 x 880 x 1960	1000	890 700-45
Treston Tower frame with castors	860 x 880 x 2105	600	890 701-45



Wide range of accessories and add-on products

Because the frame is equipped with the M750 upright frame module, almost all modular size M750 accessories are compatible with the Treston Tower storage and workstation unit. Also remember the tool hooks (R hooks) and stacking and shelf bins.

Examples of accessories and add-on products

Name	Size W x D x H mm	Max load kg	Code
1 Flow-through shelf + brackets M750*	718 x 830	150	890 710-49
2 Spacer bar, M750**			851 483-49
3 Perforated back panel M750, max 3 pcs/side	718 x 612		861 512-49
4 Hook set 3 (69 pcs)			855 003-51
Steel shelf M750	740 x 400	50	852 770-49
Bin rail M750	742 x 100	50	859 151-49
LCD monitor holder for perforated panel		10	890 715-49
Treston NaturLite Led Wing 500 (+ bracket 95/120 mm)	430 x 120 x 50		TNL500W

* A flow-through shelf can fit two 400-mm deep shelf bins successively.

** Recommended to be used with flow-through shelving.



WATCH THIS ANIMATION showcasing the versatile usage options of our technical furniture:
Treston Tower storage and workstation unit | <https://vimeo.com/360212786>

Panel hooks

Our selection includes more than 50 different kinds of hooks and brackets for the efficient storage and

organisation of tools. All the hooks and brackets can be easily attached to our perforated panels.



R1



R2



R3

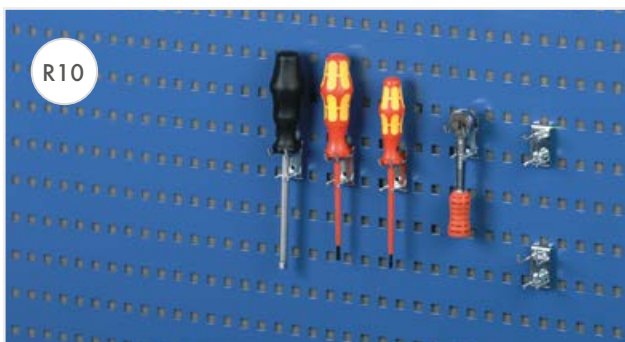

R10



R13

Hook R1

Name	L	Ø	Max load kg	Code
Hook R1	30	3	10	853 207-51
Hook R1	50	4	10	853 208-51
Hook R1	50	6	10	853 241-51
Hook R1	80	6	10	853 209-51
Hook R1	100	4	8	853 210-51
Hook R1	100	6	10	853 211-51
Hook R1	150	4	4	853 212-51
Hook R1	150	6	10	853 213-51
Hook R1	200	4	2	853 214-51
Hook R1	200	6	6	853 215-51
Hook R1	300	6	3	853 216-51
Hook R1	300	8	8	853 217-51

L = hook length mm

All order numbers include 5 pcs.

Hook R2

Name	L	Ø	A	Max load kg	Code
Hook R2	33	3	17	10	853 218-51
Hook R2	43	4	25	10	853 219-51
Hook R2	43	4	40	10	853 220-51
Hook R2	100	6	25	10	853 221-51
Hook R2	150	4	16,5	6	853 222-51
Hook R2	150	6	25	10	853 223-51
Hook R2	200	6	25	10	853 224-51

L = hook length mm

A = free gap mm

All order numbers include 5 pcs.

Hook R3

Name	L	Ø	Max load kg	Code
Hook R3	10	6	10	853 225-51
Hook R3	50	6	10	853 226-51

L = hook length mm

All order numbers include 5 pcs.

Hook R10

Name	L	A	Max load kg	Code
Hook R10	28	9	10	853 227-51
Hook R10	33	17	10	853 228-51

L = hook length mm

A = free gap mm

All order numbers include 5 pcs.

Hook R13

Name	L	Ø	Max load kg	Code
Hook R13	157	3	1	853 229-51

L = hook length mm

The order number includes 5 pcs.

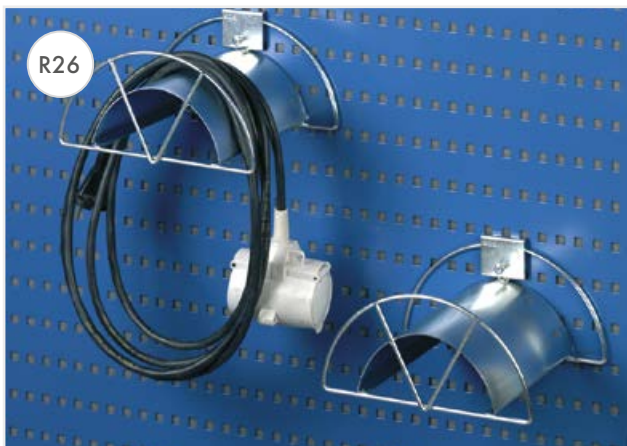
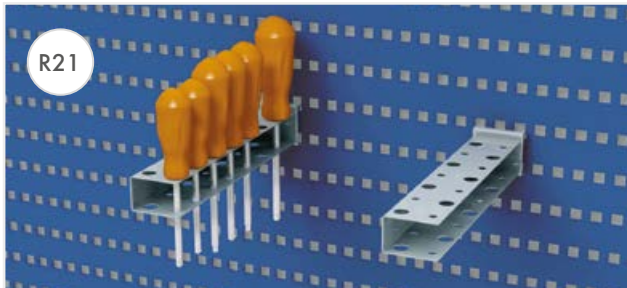
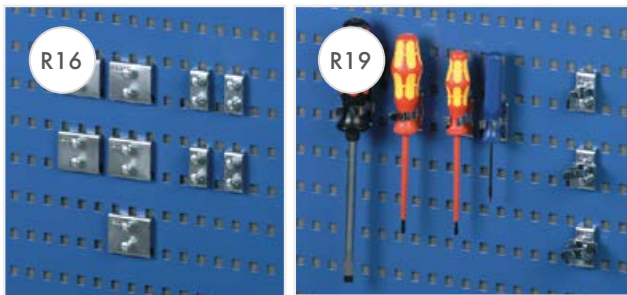

Hook R16

Name	L	Max load kg	Code
Hook R16	20	10	831 514-51
Hook R16	46	10	831 506-51

L = hook length mm

All order numbers include 1 pc.

Hook R19

Name	Ø	Code
Hook R19	13	853 231-51
Hook R19	19	853 232-51
Hook R19	22	853 233-51

All order numbers include 5 pc.

Hook R21

Name	L	Ø	Code
Hook R21	220	12	831 646-51

L = hook length mm

The order number includes 1 pc.

Hook R24

Name	L	Ø	Code
Hook R24	65	17	831 700-51
Hook R24	80	26	831 719-51
Hook R24	100	42	852 167-51

L = hook length mm

All order numbers include 1 pc.

Hook R26

Name	L	Ø	Code
Hook R26	160	10	838 896-51

L = hook length mm

The order number includes 1 pc.

Hook R29

Name	L	Max load kg	Code
Hook R29	40	5	853 234-51
Hook R29	60	5	853 235-51
Hook R29	80	10	853 236-51

L = hook length mm

All order numbers include 5 pcs.

Hook R30

Name	L	Ø	Max load kg	Code
Hook R30	35	4	10	853 237-51
Hook R30	85	6	10	853 238-51

L = hook length mm

All order numbers include 5 pcs.

Hook R33

Name	H	Ø	Code
Hook R33	30	90	832 162-51

H = hook height mm

The order number includes 1 pc.

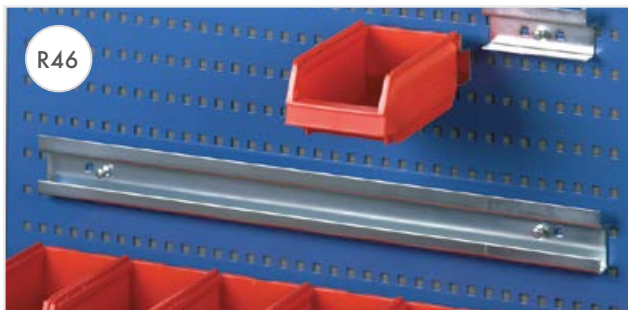
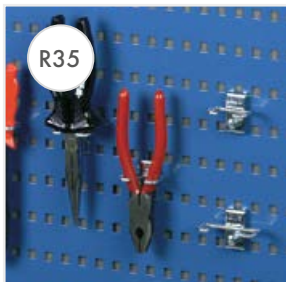

Hook R35

Name	L	A	Max load kg	Code
Hook R35	17	35	5	853 239-51
Hook R35	17	55	5	853 240-51

L = hook length mm

A = free gap mm

All order numbers include 5 pcs.

Hook R37

Name	Ø	Max load kg	Code
Hook R37	40	10	831 433-51
Hook R37	60	10	831 441-51
Hook R37	80	10	831 603-51

All order numbers include 1 pc.

Hook R41

Name	L	Code
Hook R41	556	838 357-51

L = hook length mm

The order number includes 1 pc.

Hook R42

Name	L	Code
Hook R42	238	838 365-51

L = hook length mm

The order number includes 1 pc.

Hook R43

Name	L	Code
Hook R43	238	838 373-51

L = hook length mm

The order number includes 1 pc.

Hook R46

Name	L		Code
Hook R46	112	for stacking bins 1015 and 30-1L	831 794-51
Hook R46	634	bin rail for six stacking bins 1015 and 30-1L	839 086-51

L = hook length mm

All order numbers include 1 pc.

Hook R47

Name	W x D	Max load kg	Code
Hook R47	350 x 120	4	831 654-49

The order number includes 1 pc.

Hook R48

Name	W x D x H	Code
Hook R48	235 x 200 x 370	838 380-51

The order number includes 1 pc.

Paper roll holder

Name	L	Code
Paper roll holder	300	854 043-51

L = max roll width mm



Box holder

Other supplies

Name	Size W x D x H mm	Max load kg	Code
Box holder for four pick up boxes	456 x 165 x 48	5	854 042-49
Pick up box	149 x 85 x 48		851 843-00
Utility box	410 x 155 x 90	4	854 041-49
Folder compartment	466 x 90 x 240	4	854 040-49
LCD monitor holder for perforated panel	120 x 38 x 150	10	890 715-49



Utility box



Folder compartment



LCD monitor holder for perforated panel

Hook sets

Ready-made hook sets help you to get started.

Choose the most suitable hook set for your needs from the following possibilities:

- Hook set 1 Basic light hook set
- Hook set 2 Basic hook set for hand tools
- Hook set 3 Hook set for perforated tool cabinet
- Hook set 4 All inclusive set for hand tools
- Hook set 5 Hook set for heavy tools in perforated tool cabinet



Hook sets

Hooks included in the sets (Code)	Hooks sets							
	L mm	Ø mm	A mm	Set 1	Set 2	Set 3	Set 4	Set 5
R1 (853 207-51)	30	3			5	15	10	10
R1 (853 208-51)	50	4		5	5		10	10
R1 (853 211-51)	100	6						10
R2 (853 218-51)	33	3	17	5	5	5	5	5
R2 (853 219-51)	43	4	25				5	5
R2 (853 220-51)	43	4	40					5
R10 (853 227-51)	28		9					5
R10 (853 228-51)	33		17					5
R19 (853 231-51)		13					5	5
R19 (853 232-51)		19		5	5	5	5	5
R19 (853 233-51)		22			5			5
R21 (831 646-51)	220	12			1			1
R24 (831 719-51)	80	26			1	5	7	3
R24 (852 167-51)	100	42				1	2	3
R29 (853 235-51)	60				5			5
R30 (853 237-51)	35	4		5	5	35	40	10
R33 (832 162-51)	30	90			1	1	2	1
R35 (853 239-51)	17		35		5		5	5
R35 (853 240-51)	17		55					5
R37 (831 441-51)		60			1		3	3
R42 (838 365-51)	35		238		1	1	1	1
R43 (838 373-51)	42		238			1		
Pieces				20	45	69	100	107

L = hook length mm
A = free gap mm

Spare parts

Cabinet spare parts	Product	Code
Rubber mat 550 x 420	Industrial cabinet 55/100	836 716-00
Rubber mat 799 x 420	Industrial cabinet 80/100	836 715-00

Drawer unit spare parts	Product	Code
Base	55 drawer unit	854 101-49
Top cover	55 drawer unit	854 102-49
Rubber mat 549 x 709	55 drawer unit's cover	836 717-00
Cover with rubber mat	70 drawer unit	834 904-41
Cover with rubber mat	Sliding-door cabinet	852 276-41
Rubber mat 676 x 445	71/79 drawer unit's cover / Service trolley cover	854 036-00
Cover with rubber mat 906 x 736	90 drawer unit	854 258-41
Cover with rubber mat 1304 x 736	130 drawer unit	854 259-41

Drawer interior spare parts	Product	Code
Divider, L=600	For drawer height 75	872 310-49
Divider, L=600	For drawer height 100	872 311-49
Divider, L=600	For drawer height 150&250	872 312-49
Middle plate, L=100	For drawer height 75	832 525-49
Middle plate, L=150	For drawer height 75	832 526-49
Middle plate, L=300	For drawer height 75	832 527-49
Middle plate, L=100	For drawer height 100	832 528-49
Middle plate, L=150	For drawer height 100	832 529-49
Middle plate, L=300	For drawer height 100	832 530-49
Middle plate, L=100	For drawer height 150 & 250	832 533-49
Middle plate, L=150	For drawer height 150 & 250	832 531-49
Middle plate, L=300	For drawer height 150 & 250	832 532-49
Middle plate holder set, 12 pcs		853 003-00
Divider side holder 75	For drawer height 75	854 282-49
Divider side holder 100	For drawer height 100	854 264-49
Divider side holder 150	For drawer height 150 & 250	854 265-49
Tool trough 150/4	150x150mm, 4x33 troughs	837 460-00
Tool trough 150/3	150x150mm, 3x45 troughs	837 450-00
Tool trough 150/2	150x150mm, 2x70 troughs	837 430-00
Middle plate, tool troughs, 33 mm	For tool trough 150/4	837 490-00
Middle plate, tool troughs, 45 mm	For tool trough 150/3	837 480-00
Middle plate, tool troughs, 70 mm	For tool trough 150/2	837 470-00

Castors	Product	Code
Castor set Ø 100	55 drawer unit	852 625-00
Castor set Ø 100	Storage trolley	852 768-00
Castor set Ø 100	Fitter's trolley and TP bench	834 734-00
Castor set Ø 125	Basic trolley	834 740-00
Castor set Ø 100 ESD	Storage trolley	852 774-00
Castor set Ø 100 ESD	TP bench	860 429-00
Fixed castor Ø 150	Service trolley	900 537-00
Fixed castor Ø 160	Heavy duty trolley	900 040-00
Swivel castor Ø 100	Service trolley	942 060-00
Swivel castor Ø 160	Heavy duty trolley	900 041-00
Support castor Ø 100	Tool storage system	943 690-00

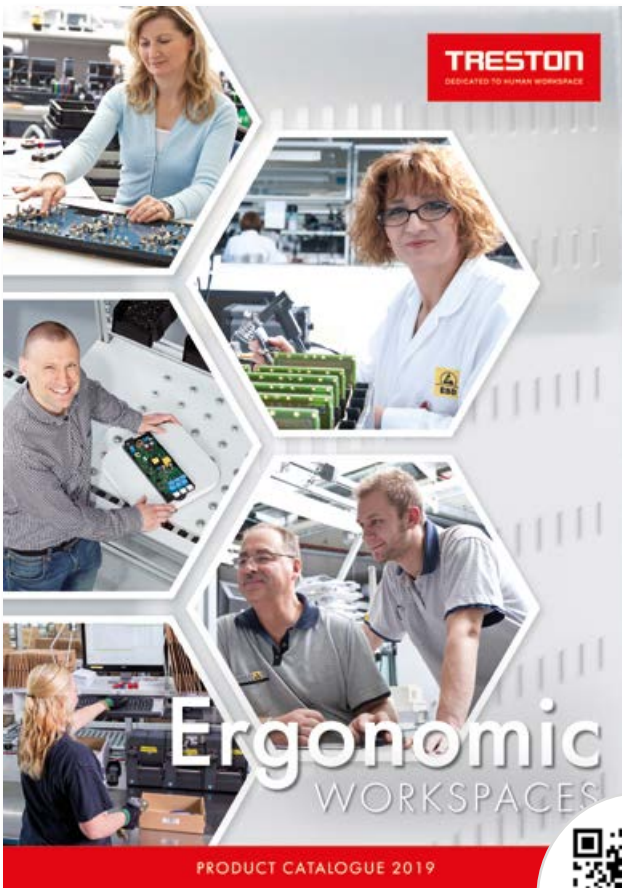

Discover also our **Ergonomic Workspaces range**

Process changes in production or operations require reconfigurable workstations that take account of individual ergonomics requirements. Our modular product solutions allow you to react to new situations and the resulting needs in an agile manner, enabling smooth, continuous operations.

For the needs of the electronics industry, we also make ESD-shielded workstations.



Discover also our **Storage Systems product range**

Our plastic storage drawers are durable and easy to clean, and can be customised into a complete storage system if necessary. Our product range also includes various stand and trolley solutions, for the more efficient use of storage space and easier movement of stored goods.

We also have storage furniture for EPAs. In addition, some of our storage solutions are based on reprocessed plastic.

HEADQUARTERS

Treston Oy
Sorakatu 1
FI-20730 Turku
Tel. +358 10 4469 11
Fax +358 10 4469 789
sales@treston.com
www.treston.com

FACTORIES

Treston Oy, Turku plant
Sorakatu 1
FI-20730 Turku
Tel. +358 10 4469 11
Fax +358 10 4469 789
sales@treston.com
www.treston.fi

Treston Oy, Jyväskylä plant
PO Box 33 (Sohlberginkatu 10)
FI-40351 Jyväskylä
Tel. +358 10 4469 11
Fax +358 10 4469 290
sales@treston.com
www.treston.fi

FRANCE

Treston France SARL
Z.A.C. de la Bonne Rencontre
1, voie Gallo Romaine, Quincy-Voisins
77334 Meaux Cedex
Tel. +33 1 64 17 11 11
Fax +33 1 64 17 11 10
infofr@treston.com
www.treston.fr

GERMANY

Treston Deutschland GmbH
Friedrich-Ebert-Damm 143
22047 Hamburg
Tel. +49 40 8816 5022 - 0
Fax +49 40 8816 5022 - 10
info.de@treston.com
www.treston.de

Treston Deutschland GmbH
Niederlassung Raunheim
Frankfurter Straße 101
65479 Raunheim
Tel. +49 6142 992 50
Fax +49 6142 9925-29
mail.de@treston.com
www.treston.de

RUSSIA

Treston Russia LLC
197375, Russia, Saint-Petersburg,
Marshala Novikova street 42
Tel. +7 812 677 76 20
info.ru@treston.com
www.treston.ru

SWEDEN

Treston AB
Enhagslingan 6
187 40 Täby
Tel. +46 8 511 791 60
Fax +46 8 511 797 60
info.se@treston.com
www.treston.se

UNITED KINGDOM

Treston Ltd
Treston House
5b Bone Lane, Newbury
Berkshire, RG14 5SH
Tel. +44 1635 521521
Fax +44 1635 37452
salesuk@treston.com
www.treston.com

USA

Treston, Inc.
156 Bluffs Court
Canton, GA 30114
Tel. +1 770-721-7980
Fax +1 770-720-6584
infousa@treston.com
www.treston.us

Premium partners

BENELUX

Human Workspace BV
Mechelaarstraat 17
4903 RE Oosterhout
Tel. +31 162 454 383
sales@humanworkspace.nl
www.humanworkspace.nl

NORWAY

Industrimøbler AS
Solheimveien 50
1473 LØRENSKOGP
Tel. +47 22 25 05 00
post@industrimobler.no
www.industrimobler.no

Treston Global Network



Treston has a long history in professional furniture design and manufacture, and well over three decades of experience in ergonomic workspace development. Our design and manufacturing facilities are located in Finland.

Thanks to our global sales network, you can receive local support and customer service anywhere in the world. We have offices in Europe and North America as well as an extensive network of selected dealers in more than 30 countries.